

AZURE

COUNTER FLOW HEAT RECOVERY VENTILATION

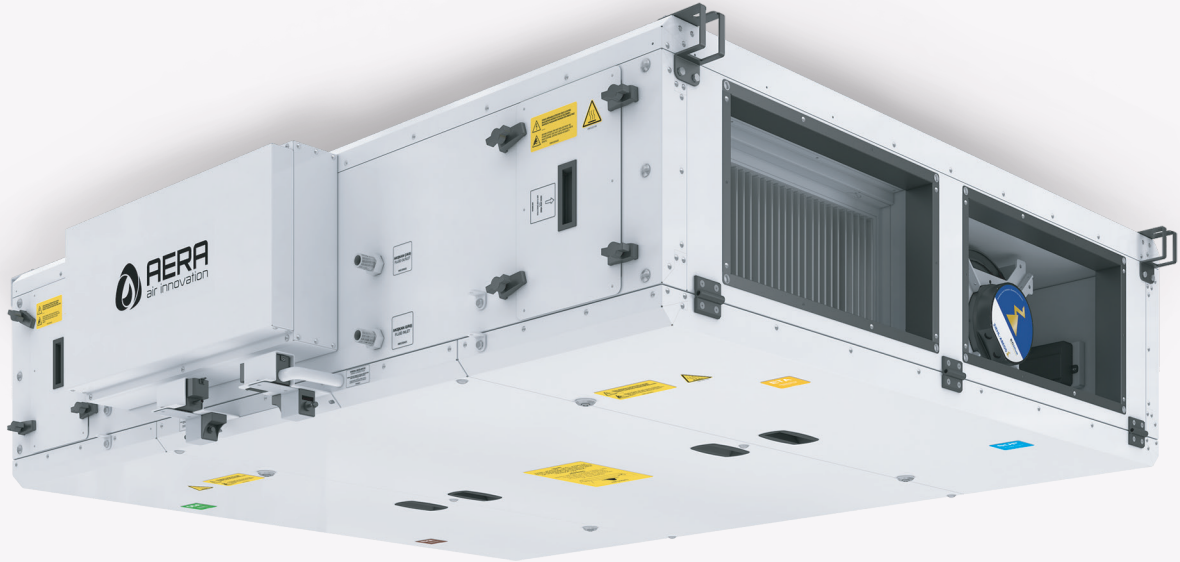

ECO
DESIGN

aera.com.tr





AERA has been founded in 2016 by national and international partners to be an important player in HVAC industry with its young but experienced spirit, innovative product design, sustainable quality control and assurance system and advanced logistics. AERA aims to present products and solutions to meet the increasing demand on energy efficiency and human comfort.

AERA is located in Izmir with its production facilities and R&D center of excellence and in Istanbul with its Sales Office. The efficiency and the effectiveness of the manufacturing is ensured with modern production and IT systems. All production processes are monitored with intensive quality control processes in accordance with the national and international regulations and norms to ensure the quality of the end product and overall efficiency.

MAIN PRODUCT GROUPS

- Modular Air Handling Units
- Compact Air Handling Units
- Heat Recovery Ventilators
- Ventilation Units with Heat Pump
- Water Terminal Units (Fan Coils)
- Chillers



AZURE units are designed to meet today's increasing energy efficiency demand using heat recovery and low electrical energy consumption. Units are built using high technology modern components optimised for market needs and state of the art control systems.

Unique features of AZURE units

- High thermal efficiency, counterflow plate heat exchanger ($\eta_t > \% 93$).
- F7 on fresh air side, M5 class filter on exhaust air.
- High sound and heat insulation with 50 mm at the casing, 50 mm rock wool insulation on service doors.
- Optional electric preheater and water after heater integrated in the casing.

With advanced web interface automation, constant air flow (CAV), constant pressure (VAV), heating / cooling capacity control, extended alarm options, by-pass ventilation, yearly timer, CO2 or humidity sensor option with filter pollution, ventilation on demand, connection to building automation systems and many other control options.

AZURE units consist of panels with high sound and heat insulation and rock wool insulation. It is made of Aluzinc sheet with high resistance to corrosion. The appliance is easily serviceable between the designed service doors and the suspended ceiling.

AZURE devices are designed in 6 different models between 150 m³ / h and 3500 m³ / h air flow requirement. F7 class filter is provided on the fresh air side of the units and M5 class filter is provided standard on the exhaust side. The units are produced according to European Union energy criteria and have ECO-DESIGN label. Supply air can be brought to the desired conditions with the optional electric preheater and hot water heater located inside the units.

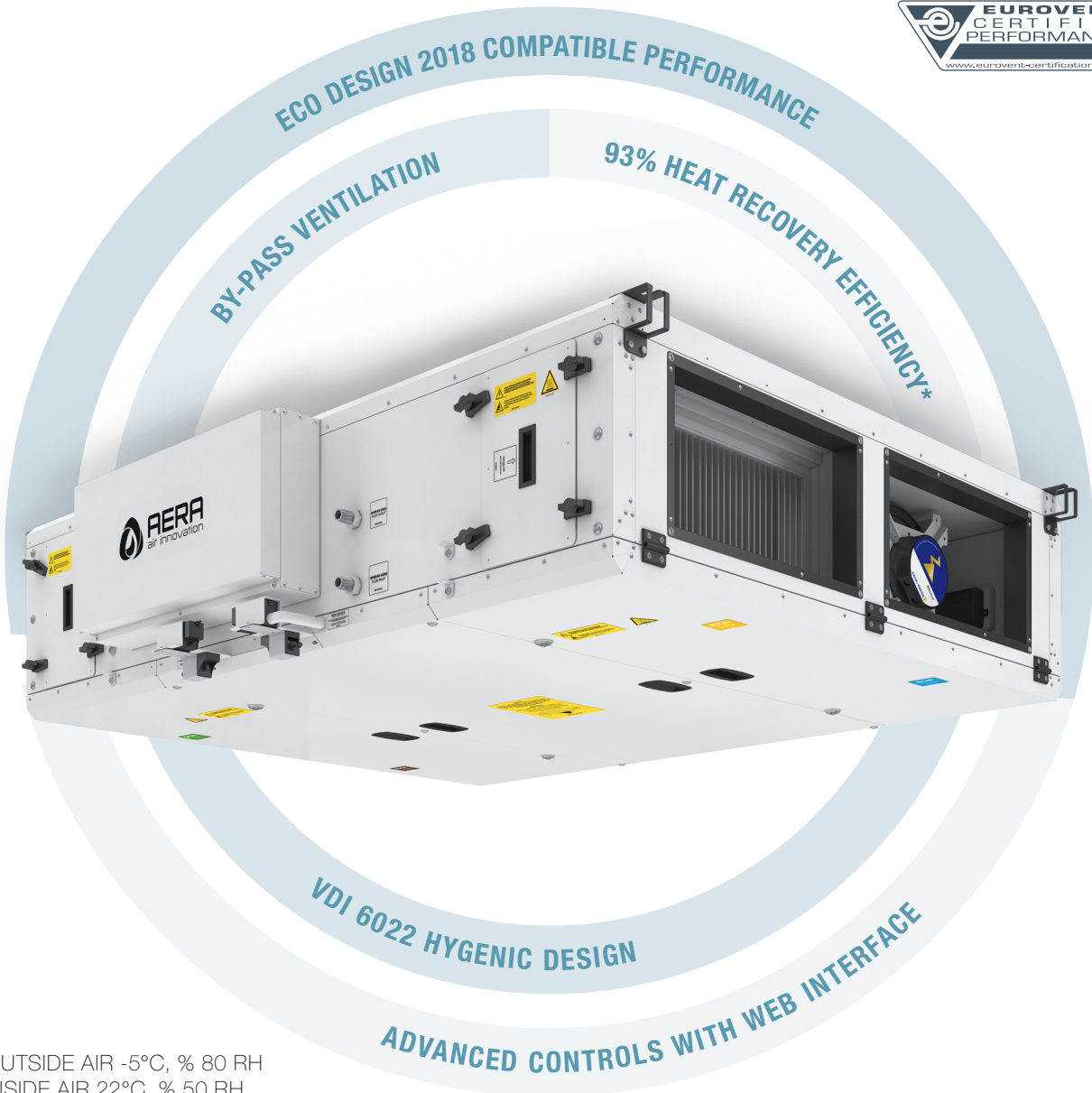

* OUTSIDE AIR -5°C, % 80 RH
INSIDE AIR 22°C, % 50 RH

All manufacturers are legally obliged to follow ECO-DESIGN directives, which are a set of the European Union's regulations that state use of energy for energy-consuming products. LOT6 of the directive reviews the ventilation devices and air handling units and is effective in the European Parliament with the EU directive number 1253/2014 and 1254/2014. The ECO-DESIGN directives, prepared by the European Council for the purpose of replacing low energy-efficient products in the market with those of high efficiency, have been accepted as a prerequisite for CE marking with the dates specified and the entry of non-conforming devices into EU countries is prohibited.



Within the scope of the ECO-DESIGN directive, which has been in force since January 1st 2016, a number of sub-limit values have been defined for air handling units, such as fan, heat recovery exchanger and filter efficiency. There are also directives concerning the operation of the air handling unit.

ECO-DESIGN Application Criteria

For which applications does the ECO-DESIGN directive apply?	The Directive has been created for ventilation devices and air handling units where some or all of the air contaminated by human activity or building emissions in the interior is replaced by fresh air from outside.
Device Classification	Residential Ventilation Equipments (RVU) $Q_{max} \leq 250 \text{ m}^3/\text{h}$ Non-Residential Ventilation Devices (NRVU) $Q_{max} > 250 \text{ m}^3/\text{h}$ Residential Ventilation Devices (RVU) * $1000 \text{ m}^3/\text{h} > Q_{max} > 250 \text{ m}^3/\text{h}$
Implementation Schedule	Tier 1: January 1, 2016 Tier 2: January 1, 2018
Unit Exceptions	<ul style="list-style-type: none"> ■ Agricultural ventilation applications ■ Transportation applications ■ Exhaust hoods in industrial kitchens ■ Fresh air or exhaust devices with a power consumption of 30 W or less and a one-way airflow ■ Bi-directional flow devices with a power consumption of 30 W or less for each fan ■ Axial or radial fans in a body according to EU 327/2011 ■ Fans operating in explosive atmosphere ■ Emergency fans ■ Fans operating at very high or very low temperatures

* In cases where the manufacturer states that it is for residential use.

Unidirectional Ventilation Units (UVU)

The model device is defined in the directive as follows.

- Airflow is one-way (supply or exhaust only).
- On the inlet side there is a class F or better filter.
- There are one or more fans in the same air line inside the device.

In the Directive, the limit value for minimum fan efficiency and SFP_{int} is specified as follows.

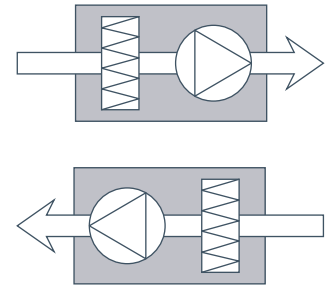

		ErP 2016	ErP 2018
Minimum Fan Efficiency η_s (%)	$P \leq 30$ kW	$6,2 \times \ln(P^*) + 35$	$6,2 \times \ln(P) + 42$
	$P > 30$ kW	56,1	63,1
The maximum allowed SFP_{int} [W/(m ³ /s)] value for the model device		250	230
Variable speed drive requirement		Yes	Yes
Obligation to monitor pressure drop for filters		No	Yes

* Nominal Effective power supply at nominal external pressure and air flow, including electric power supply (kW), fan motors and drives of motors.

Bidirectional Ventilation Units (BVU)

The model device is defined in the directive as follows:

- Airflow is bidirectional (with supply air and exhaust)
- There is a class F on the supply air side and a class M filter on the exhaust side.
- The unit has a heat recovery system.

In the Directive, the limit value for minimum fan efficiency and SFP_{int} is specified as follows:

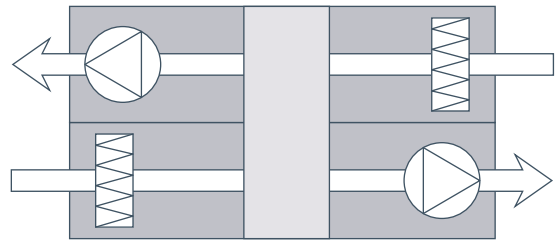

		ErP 2016	ErP 2018
Heat recovery system with thermal by-pass mandatory		Yes	Yes
Thermal Efficiency (EN308)* η_t [%]	Plate / Rotary HR	67	73
Maximum allowed SFP_{int} value for model device	Plate / Rotary HR	$q^{*2} < 2$ m ³ /s	$1.200 + E - 300 \times q / 2 - F$
		$q \geq 2$ m ³ /s	$900 + E - F$
HR efficiency add-on, E	Plate / Rotary HR	$(\eta_t - 67) \times 30$	$(\eta_t - 73) \times 30$
Filter correction coefficient, F	Model Unit	0	0
	No M filter	160	150
	No F filter	200	190
	No M + F filter	360	340
Variable speed drive requirement		Yes	Yes
Obligation to monitor pressure drop for filters		No	Yes

*1 EN 308 conditions are internal and external weather conditions where condensation has not occurred and should be taken as follows. **OUTDOOR AIR CONDITIONS:** 5 °C **ROOM CONDITIONS:** 25 °C, 28 % RH

*2 Air flow at the working point of the device (m³/s)

SFP_{int} Value and Calculation Method

According to EN 13779, the SFP is calculated as the ratio of the fans of the air supply unit provided by the unit.

In ECO-DESIGN directives, the SFP value is redefined as SFP_{int}. The SFP_{int} value relates to the performance of the components used in the design of the device, and does not add any inefficiencies in the ducting system. This provides a more accurate comparison between units. The internal losses to be taken into account in the SFP_{int} calculation are pressure losses in the heat recovery exchanger, filter and housing.

Sample Calculator: The table below shows the operating point for the internal pressure drops in a heat recovery ventilator. The SFP value is compared with the SFP_{limit} value specified in the ECO DESIGN criteria, calculated by these values and fan efficiencies. If the SFP interior is smaller than the SFP_{limit} the device meets the ECO DESIGN criteria.

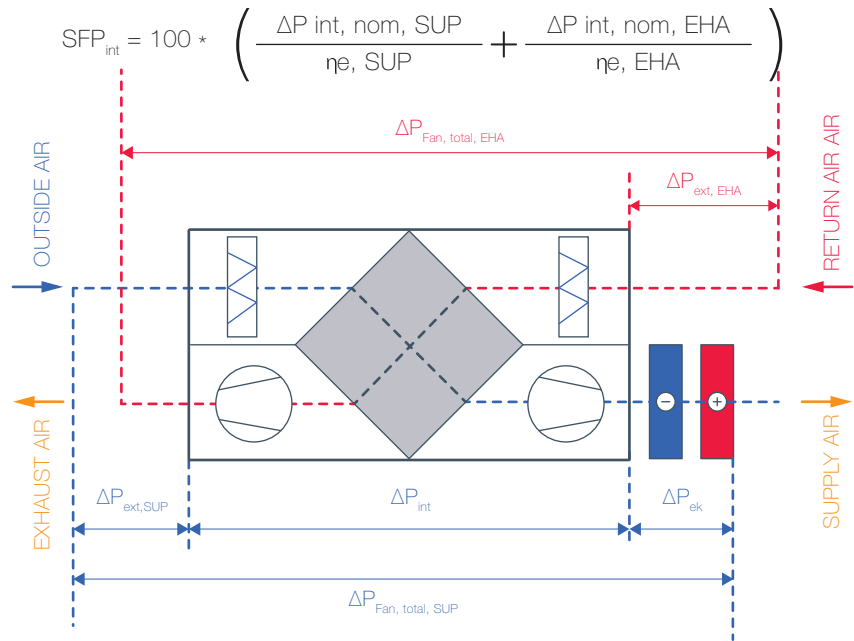

	Intra-device pressure loss [Pa]				External Static pressure (Pa)	Fan efficiency at the operating point (including external static pressure)	SFP _{int}
	HR Exchanger	Supply Air Filter (F7) Exhaust Air Filter (M5)	System Loss	Total			
Supply Air	179	109.97	44.75	333.72	100	0.596	559.9
Exhaust Air	180	90.86	44.75	315.61	100	0.596	529.5
SFP_{int}, total							1089.5

Filter Correction Factor, F	M5 and F7 filter	0
HRE efficiency addition, E	($\eta_r - 0.67$) * 3000	30
SFP_{ie}, limit (2016)	1200 + E - 300 * q_{nom} / 2 - F	1146.66

Where the ventilation unit is not designed for a single operating point, compliance with the ECO-DESIGN directive should be indicated on the unit operating curves. The following is an ECO-DESIGN performance curve for an air handling unit with variable airflows.

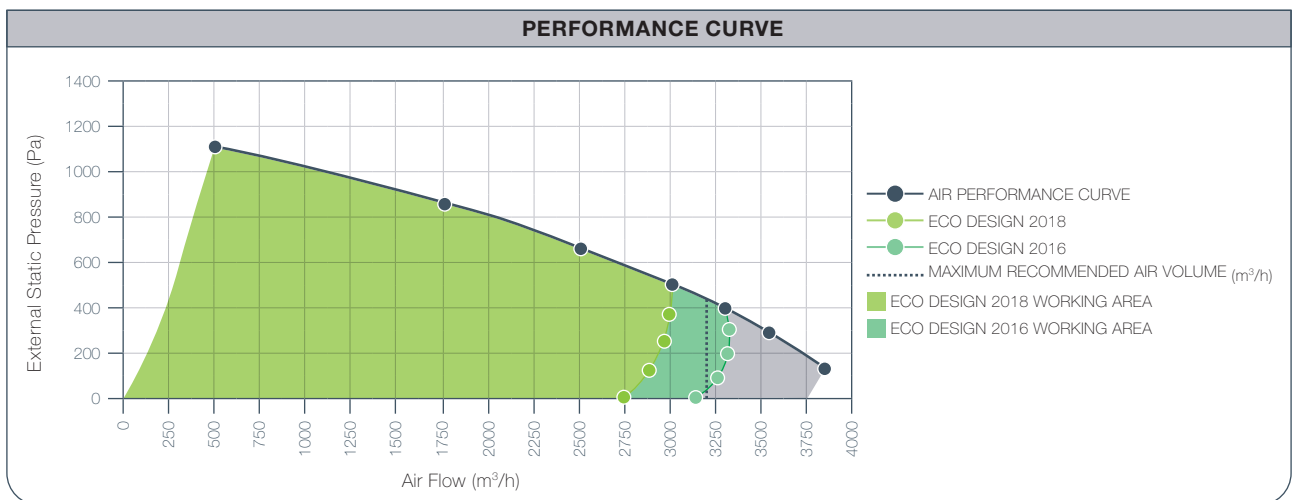

FAN PERFORMANCE CURVES

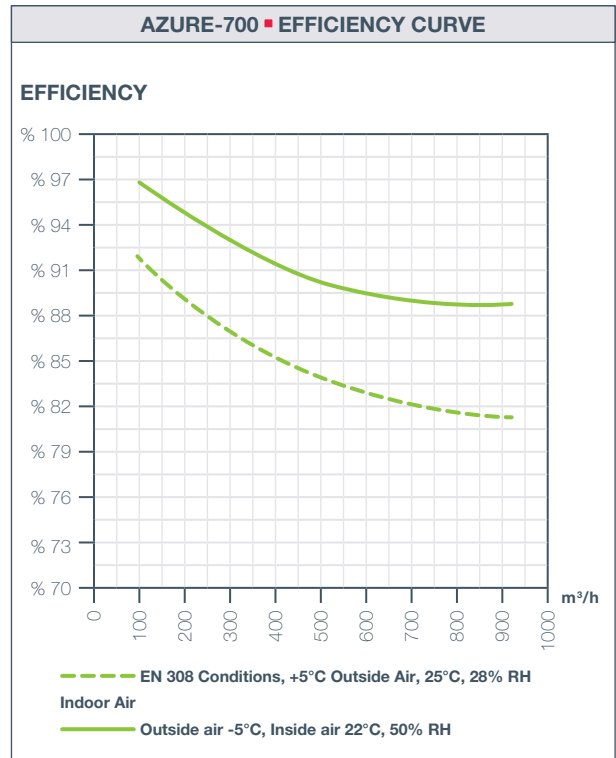
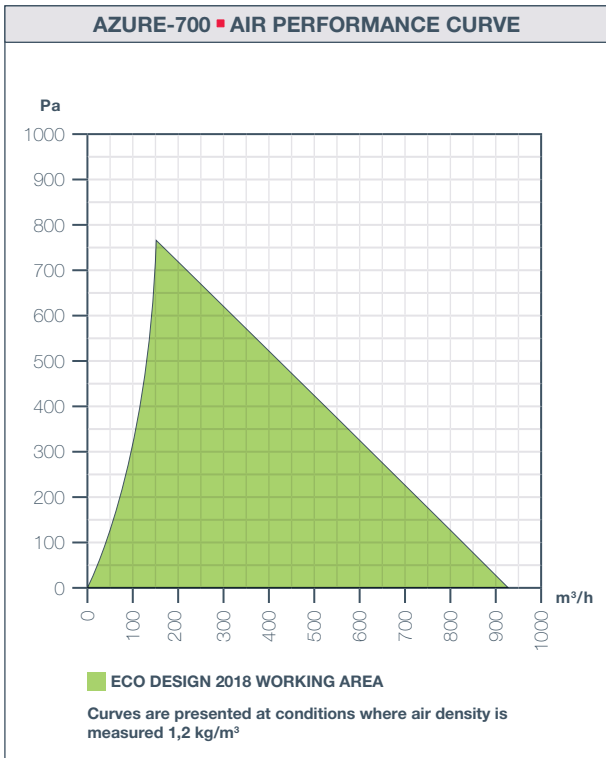
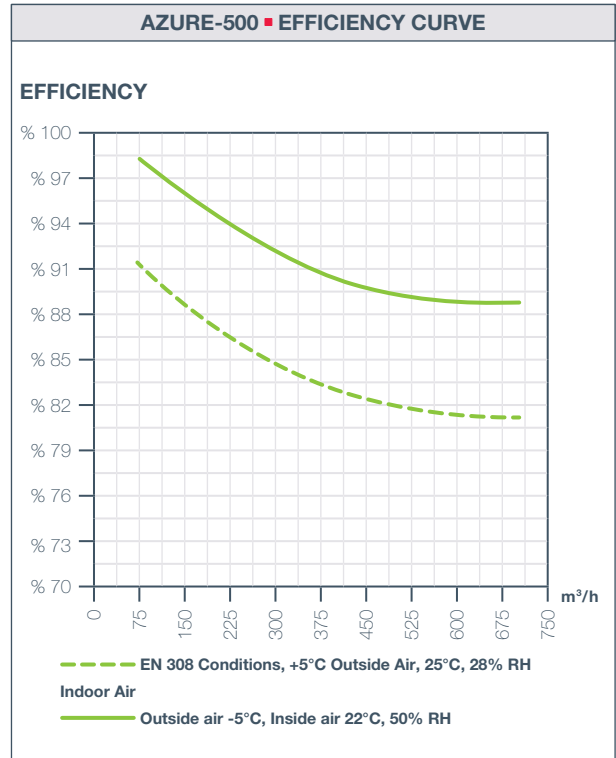
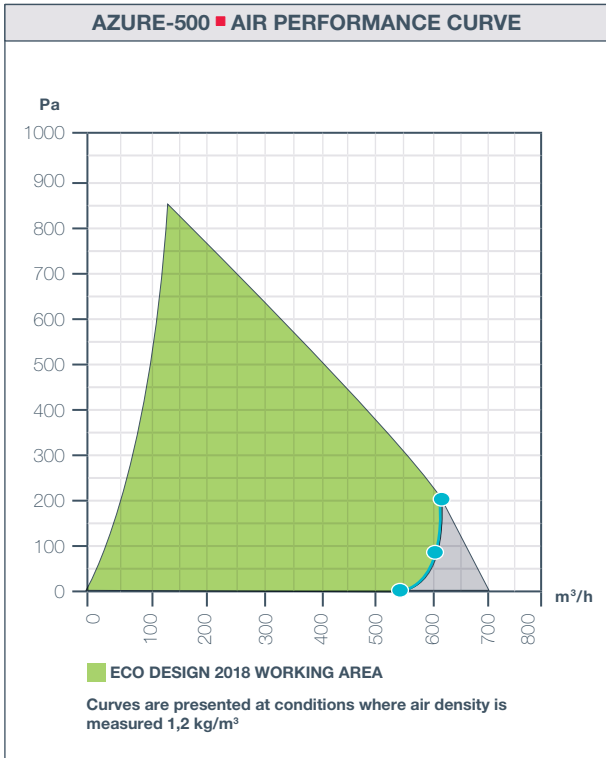

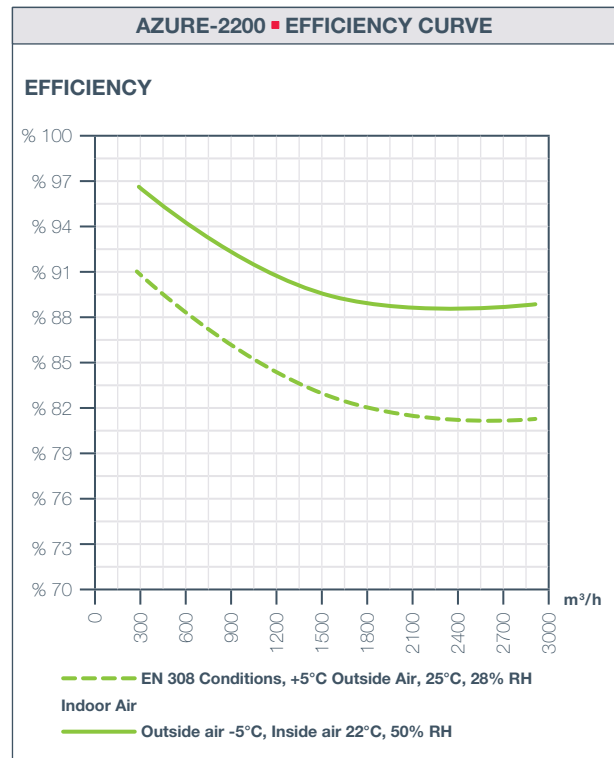
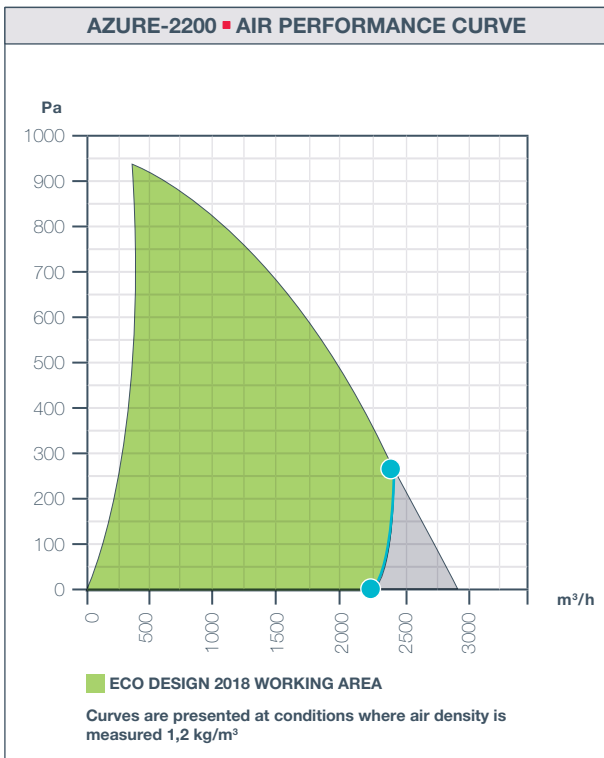
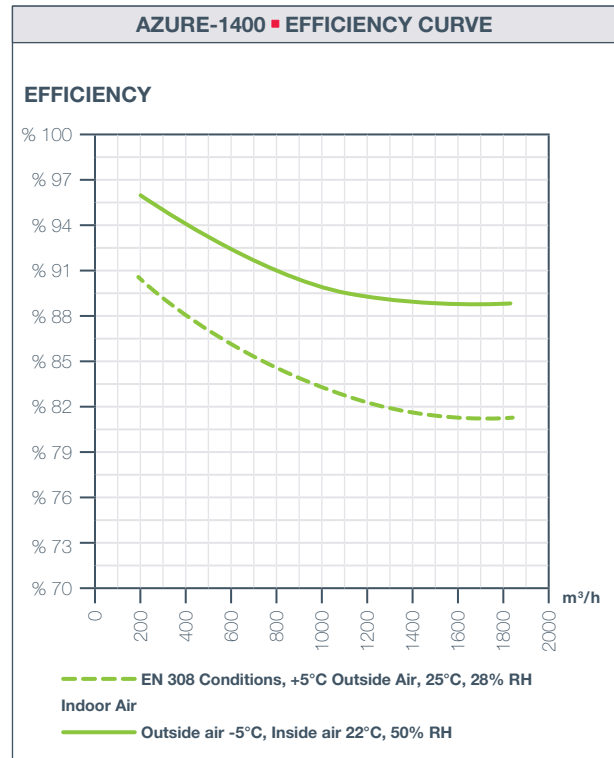
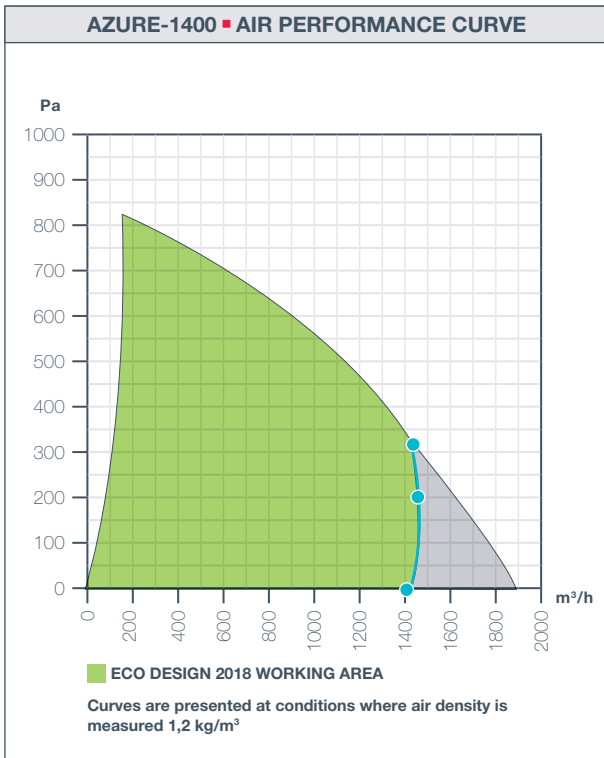

FAN PERFORMANCE CURVES

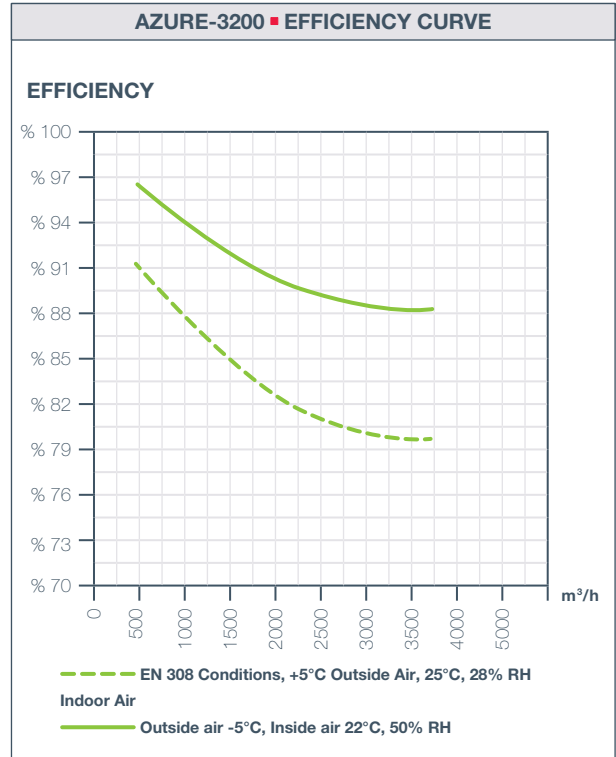
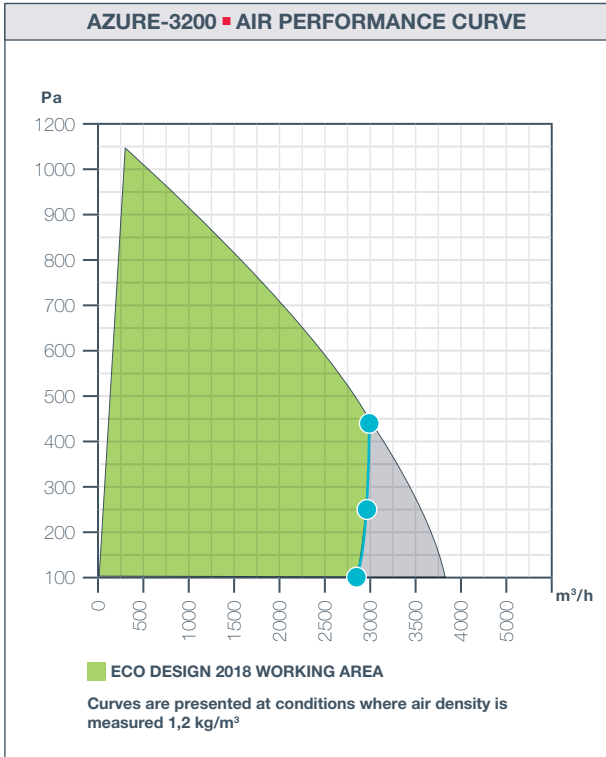

MODEL					
	500	700	1400	2200	3200
MAXIMUM AIR FLOW (m ³ /h)	700	900	1850	2750	3700
MAXIMUM POWER CONSUMPTION (kW)	338	340	1000	1000	2000
MAXIMUM CURRENT (A)	2,70	2,80	4,40	4,40	3,20
SUPPLY VOLTAGE	230 V / 50 Hz / 1 ~				380 V / 50 Hz / 3 ~
FILTER CLASS (EXHAUST/FRESH AIR)	M5/F7	M5/F7	M5/F7	M5/F7	M5/F7
WEIGHT (kg)	130	155	200	285	370
SOUND PRESSURE (dB)	42	47	54	52	54

Sound values are measured for a ducted unit at 250Hz and 1,5m away from the unit.

The filter class is specified according to EN779: 2012 standard.

Max Air Volumes are Indicated according to 0 Pa static pressure loss.

DIMENSIONS

MODEL		DIMENSIONS [mm]					
		L	D	H	L2	D2	AxB
AZURE	500	1540	925	383	1578	820	150x300
	700	1590	1100	385	1628	995	200x400
	1400	1715	1400	425	1753	1295	250x500
	2200	1940	1770	508	1978	1665	300x500
	3200	2090	2020	594	2128	1915	400x700

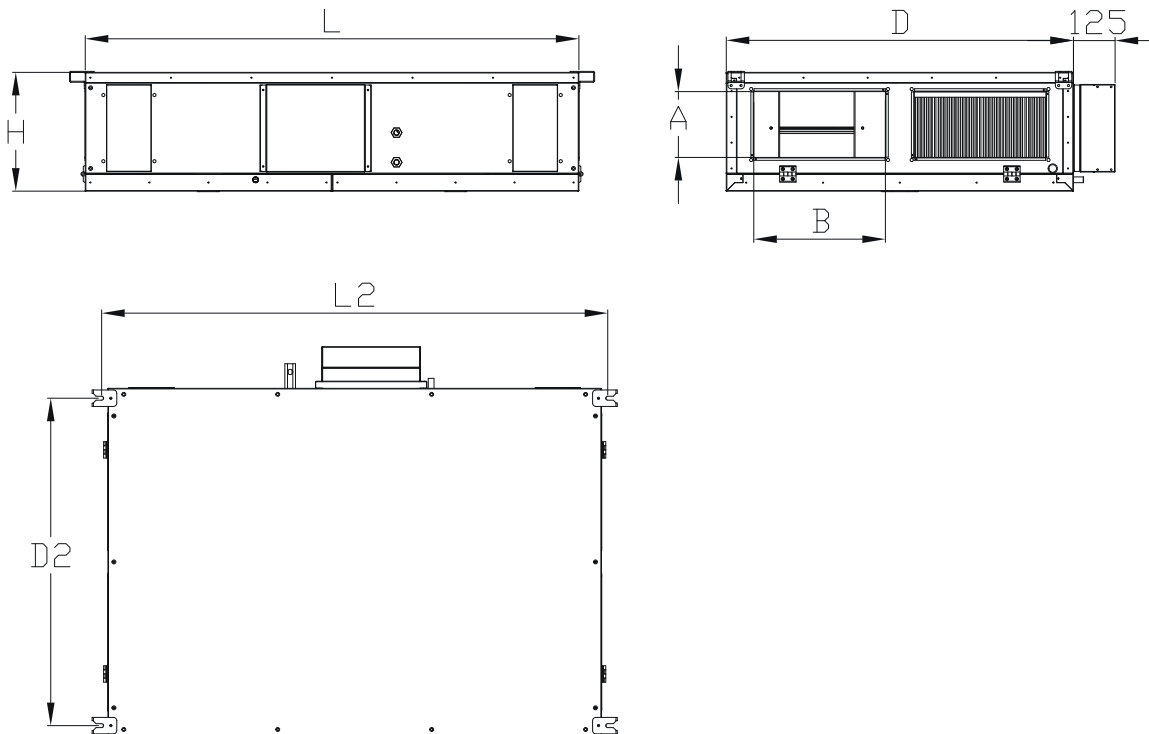

CASING

By using advanced technology components, Azure units achieve efficiency levels of today's and tomorrow's standards. The casing, which is developed using the latest engineering methods, also shows superior performance in terms of aerodynamics. The internal turbulence or dead zone losses are reduced to the minimum with the analysis.

In addition to achieving a high-strength design with patented fan support bracket design, the total efficiency is improved by avoiding dead zones and reverse flows which may occur behind the fan body.

AZURE units are designed with low air velocities, low filter and coil pressure drops are achieved despite its compact design. The fact that the electric preheater and the water type after heater can be placed inside the body contributes to the compact structure, preventing difficulties in wiring and automation. Water heating battery's piping has a specially designed connection, it provides high sealing and easy connection out of the casing.

AZURE units are designed in accordance with VDI6022. Inside of the unit is easily cleanable. The used seals are closed cell and prevent germ reproduction. All components that require service, have their own service doors. This way the unit does not have to be disconnected from ducting system for servicing.

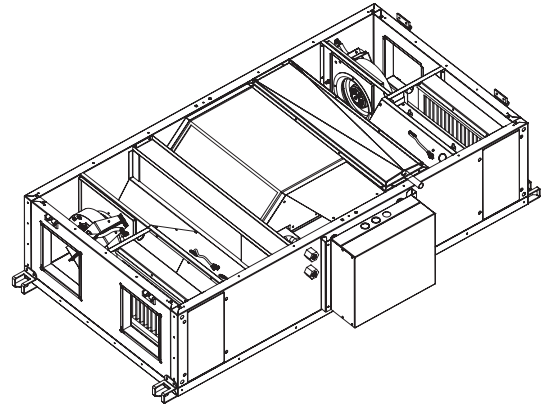

FILTER

AZURE units are produced with F7 class on the supply air side and M5 class filter on the exhaust side as ECO-DESIGN directives. With these highly efficient filters, indoor air quality is increased by keeping 90% of dust and particles up to diameter of 0,4 μm in the indoor environment.

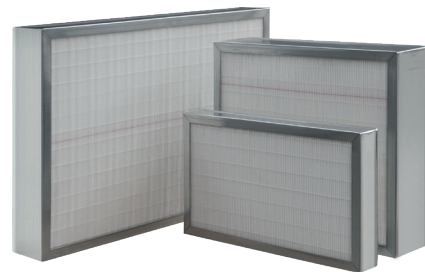

AZURE units are produced with F7 class on the supply air side and M5 class filter on the exhaust side as ECO-DESIGN directives. With these highly efficient filters, indoor air quality is increased by keeping 90% of dust and particles up to diameter of 0,4 μm in the indoor environment.

FAN

AZURE units are designed with high energy efficient, low sound pressure and low power consumption plug fans. All the fans are compliant with ECO-DESIGN criteria by European Union Energy Comitee and ErP 2015.

Plug fans with EC motors can be driven with 3 fixed speeds or steplessly with the help of an air quality sensor thanks to built in smart control system SENSO PLUS.

Plug fans with EC motors are AC-powered fans with DC motor technology. DC motor provides high electrical efficiency while it can be connected to AC mains via on board converter. It is perfectly in harmony with the hightech electronic components used and magnetic noise transmitted to the network is prevented.



Heating Coils

Water heater coils used in AZURE units can be installed in the unit. Coils are designed for standard capacities and they heat the air to the required supply air temperature.

Duct type cooling coils have drain pans, and an insulated casing to prevent condensation. Both heating and cooling coils can be separately controlled from Senso Plus control system.

WATER HEATER MODEL	CAPACITY	WATER REGIME
POWH 300 AZ	1,2 kW	80/60°C
POWH 500 AZ	2,0 kW	
POWH 700 AZ	2,8 kW	
POWH 1400 AZ	5,6 kW	
POWH 2200 AZ	8,8 kW	
POWH 3200 AZ	12,8 kW	

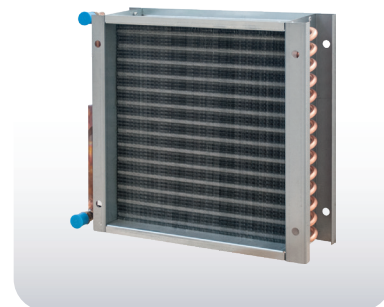

*Heating coils are shipped with an integrated frost protection temperature sensor and a 2 way valve.

Duct Type Silencer

Sound Absorbers are designed considering VDI 6022 and DIN 1946 hygiene criteria. They are produced using A1 fire class stonewool according to EN 13501, in a sheet metal casing. A sleeve is used to prevent the rockwool particles into air flow. Rectangular shaped silencers can be installed to the units duct connection spigots.

SILENCER MODEL	SOUND ATTENUATION (250 Hz)	LENGTH
SA 300 AZ	6 dBA	L=600 mm
SA 500 AZ		
SA 700 AZ		
SA 1400 AZ	5 dBA	
SA 2200 AZ		
SA 3200 AZ		



Silencers are produced using 30 mm rock wool insulation perforate sheet on the inside, aluzinc sheet metal on the outside.

Electrical Heater

Electrical preheaters are designed for cold/extra cold climates to prevent condensing air from freezing. The preheaters are designed to fit inside the unit, 2 safety thermostats are supplied as standard with all units for extended safety.

ELECTRICAL HEATER MODEL	CAPACITY	CONTROL STEPS	VOLTAGE SUPPLY
PREH 300 AZ	1 kW	1 Step Control	230 V, 50Hz
PREH 500 AZ	1,6 kW		
PREH 700 AZ	2,3 kW		
PREH 1400 AZ	4,5 kW	3 Step Control	380 V, 50Hz
PREH 2200 AZ	7,1 kW		
PREH 3200 AZ	10,4 kW		



*The electric preheater is integrated into the casing of the device, and the electric after heater is manufactured as duct type.

SENSO PLUS CONTROL SYSTEM

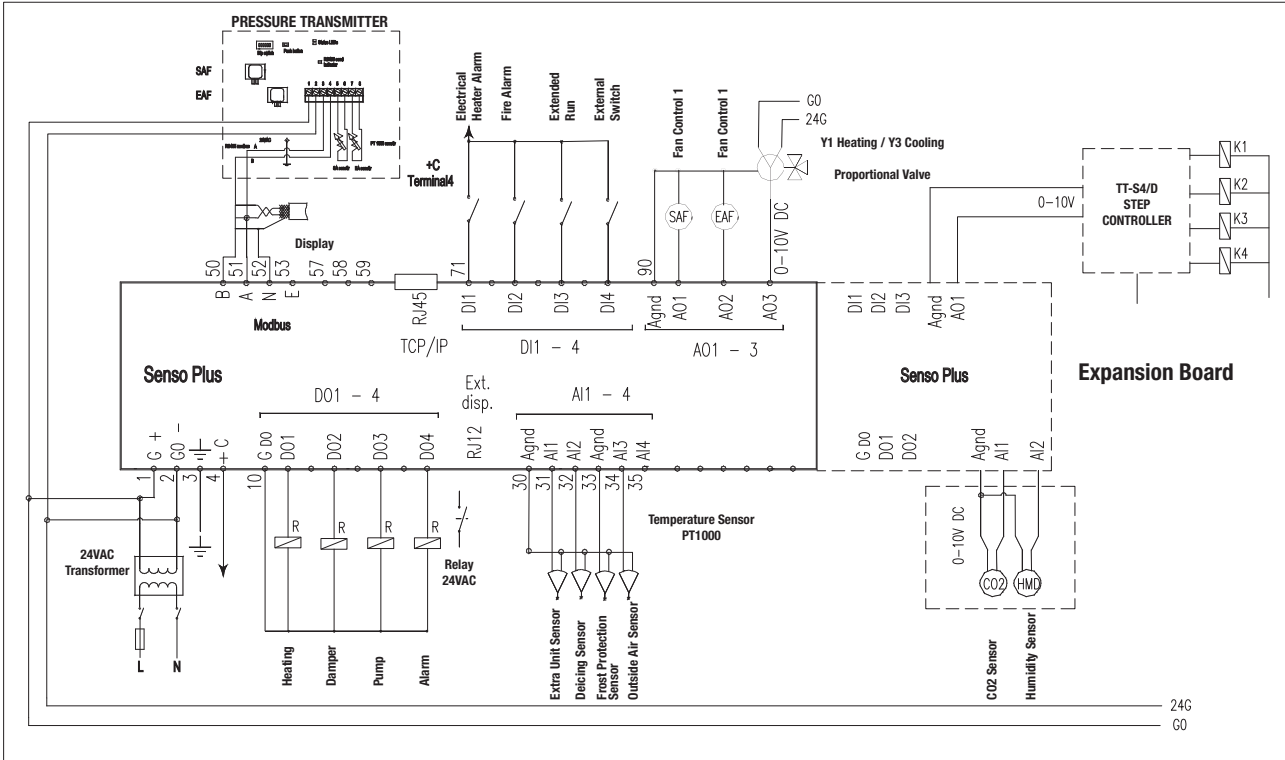

The advanced control system SENSO PLUS in AZURE Units, provides the most efficient control of all components which can be installed internally and as external accessories, ensuring the desired airflow conditions.

Electrical Pre-Heater

Electric heaters in Azure Units are used for preheating fresh air from the outside for protecting the heat exchanger from freezing. With SENSO PLUS control, electric heaters are driven optionally in 7 steps according to the desired set temperature and energy saving is ensured. All of the safety and operating equipment required by the electric heater is supplied standard with the SENSO PLUS control

Heating Coil

Heating coils are used for increasing the supply air temperature and for bringing the supply air to the desired temperature after dehumidifying process. Hot water coils can be driven by proportional control via 2 or 3 way valves. With the SENSO PLUS control, frost protection mechanism is available as standard to prevent the temperature of the supply water from reaching freezing conditions in extreme cold climates. If the return water temperature falls below a certain value set on the control, the heating valve is switched to the 100% open position and a run signal is sent to the heating water circulation pump. If the temperature still does not rise to the desired value, the device is stopped and the user is given a freeze alarm.

Cooling coil

Externally mounted duct-type water cooling coils are used for such purposes as lowering the blowing temperature and dehumidifying the air in the units. It can be driven either proportionally or by on / off method.

DX Coil

Externally mounted duct type DX batteries are used for purposes such as lowering the supply air temperature, dehumidifying process and bringing the blown air to the desired temperature after dehumidification. It can be step controlled with on / off method, maximum 8 step setting is available.

Constant Air Volume

To meet the desired constant airflow requirement in the AZURE Handling Units, the SENSO PLUS control measures the air pressure drop in the suction ports of the fans and compares the air flow with the set value to produce a working signal that will change the EC fan fan speed.

Contamination of the filters can be controlled by static flow control within the fan operating curve, to the static pressure requirements of the unit which result in higher or lower than the project values.

Constant Air Pressure

In AZURE Units, constant pressure control is used to meet the variable airflow requirement of the air duct system. The SENSO PLUS control generates a working signal that will change the EC fan fan speed by continuously measuring the static pressure created in the supply air duct and comparing it with the value defined in the system. When a VAV damper opens or closes, higher or lower external static pressure needs can be met with constant pressure control within the fans operating curve. This way extreme noise in the ducts, unbalanced airflow distribution in different volumes is prevented.

Indoor Air Quality Control

The air quality sensor or the CO2 sensor, which is placed in the critical volume or return channel in the interior, continuously measures the air quality. This value generates a signal that will change the EC fan fan speed by comparing it to the set point on the controller. If the indoor air quality is lower than the desired value, the fan speed and thus the fresh air amount is increased; if the indoor air quality is higher than the desired indoor air quality, the fan speed and fresh air speed are decreased; Energy saving is achieved in considerable amounts in heating or cooling loads caused by fresh air.

By-Pass Ventilation

In AZURE Units there is a by-pass damper in order to be able to deliver the outside air directly into the exchanger without entering the heat exchanger under suitable weather conditions. The SENSO PLUS control uses temperature sensors to determine when the by-pass will be turned on and off. This function, also known as Free Cooling, saves energy by opening the by-pass dampers when the outside air is suitable.

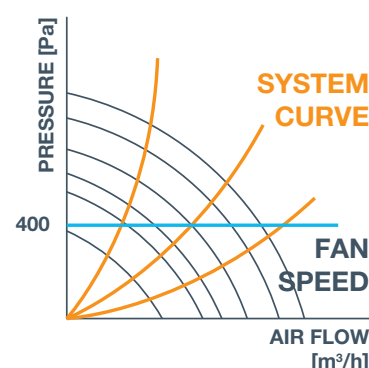
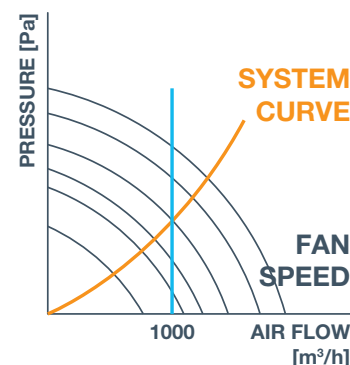

FILTERS

The pressure drops of the filters used to clean the air, can be controlled by SENSO PLUS control. Users are notified about the filter cleaning and replacement intervals. Pressure drop control can be made according to a constant pressure drop (Static) or variable air flow (Dynamic). Especially with units designed with variable speed fans, Dynamic Filter Control enables filter service at the right time.

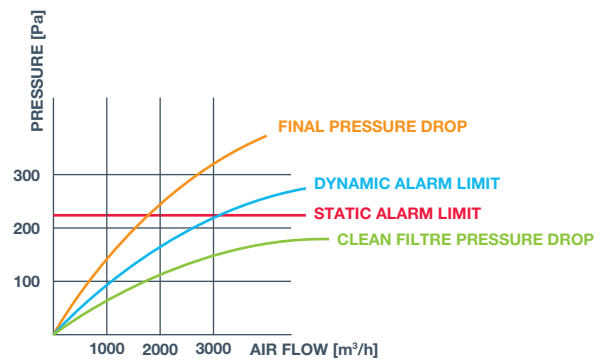

HUMIDITY CONTROL EQUIPMENT

Humidity control equipments are used to raise or lower the humidity of the supply air. With the SENSO PLUS control, the humidifier / de-humidifiers can be controlled to bring the supply air to the desired humidity value.

The SENSO PLUS control also provides system control besides equipment control, which means that the devices can be operated with the Yearly Timer Function according to the working periods: Daily, Weekly, Monthly or Yearly. In the Timer Function, values such as weekly working days, vacation times, daylight savings time can be defined and reported retrospectively.

Besides, the Support Function which is used to prevent the undesired conditions from occurring indoors even when the device is not working. The indoor temperature from falling below or exceeding a certain value even during non-working hours is ensured.

COMMUNICATION OPTIONS

SENSO PLUS control supports all of the universal communication protocols and interacts with other air handling units as well as with other building automation systems. ModBUS, BACnet and EXOline protocols are open as standard and there is also possibility to connect with LONWORKS protocol as an option.



ROOM CONTROL PANEL

With SENSO PLUS control, a standard control panel with a keypad as a user interface is delivered, optionally touch screen user interfaces are available as well. There is also a web server embedded in the card for monitoring and controlling the device through a computer. Settings for the controller can be done over the server, instantaneous operating values of the unit can be seen, as well as retroactive working values can be followed.



WEB INTERFACE (CLOUD CONTROL)

SENSO PLUS control connects the web server over the internet and allows you to view and change the settings of your unit on any computer / tablet or mobile phone anywhere in the world. No need for complicated network settings, only a connected network cable is enough. With this feature, it is possible to monitor and control all units from different projects on a single screen, so that all of the operating values, active alarms, settings can be observed and remotely changed. Cloud control is an option provided with SENSO PLUS, which is especially convenient when it is important to serve multiple devices within seconds, in different projects all around the world.

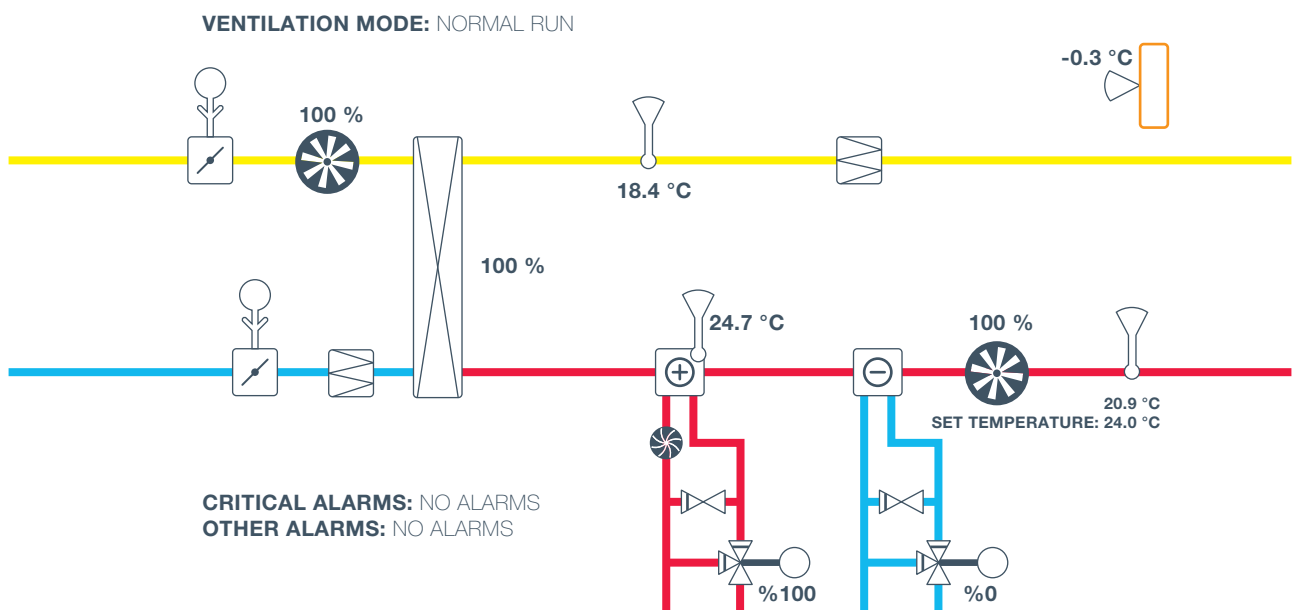

SENSO PLUS CONTROL SYSTEM

UNIQUE ADVANTAGES OF SENSO PLUS CONTROLS

- TCP / IP connection: The integrated web control console provides platform-independent remote monitoring and setting.
- Tablet, PC, smartphone provides you with 24/7 accessibility to your unit.
- BACNet, Modbus, EXOline, LON and CLOUDigo communication ports provide easy integration into all automation systems.
- With the modular structure, components in the unit can be added or deactivated after the installation.
- It provides a quick and easy configuration program from the computer and ease of operation with plug-and-play logic.
- Energy is saved;
 - By providing fresh air as much as the volume needed, it optimizes the air conditioning load resulting from fresh supply air.
 - Runs all components at their optimum points to achieve the desired supply temperature.
 - It optimizes the heat recovery operation according to indoor and outdoor weather conditions, provides free cooling at appropriate temperatures.
 - Provides filter service by constantly observing the pressure drops over the filters and informing the user accordingly.
- It provides instant information about problematic components with advanced alarm signals.
- All components of the control are supplied from a single point, so they fit perfectly and work seamlessly.
- The optional CLOUDigo platform; The system, which allows you to extend and is designed with maximum convenience, is ready to use when you plug in an ethernet cable. All devices using the SENSO PLUS control system can be viewed and controlled from a single screen.
- The devices continuously send data to the system and the data are recorded. Reports on energy efficiency can be generated by analyzing detailed data within specific dates.

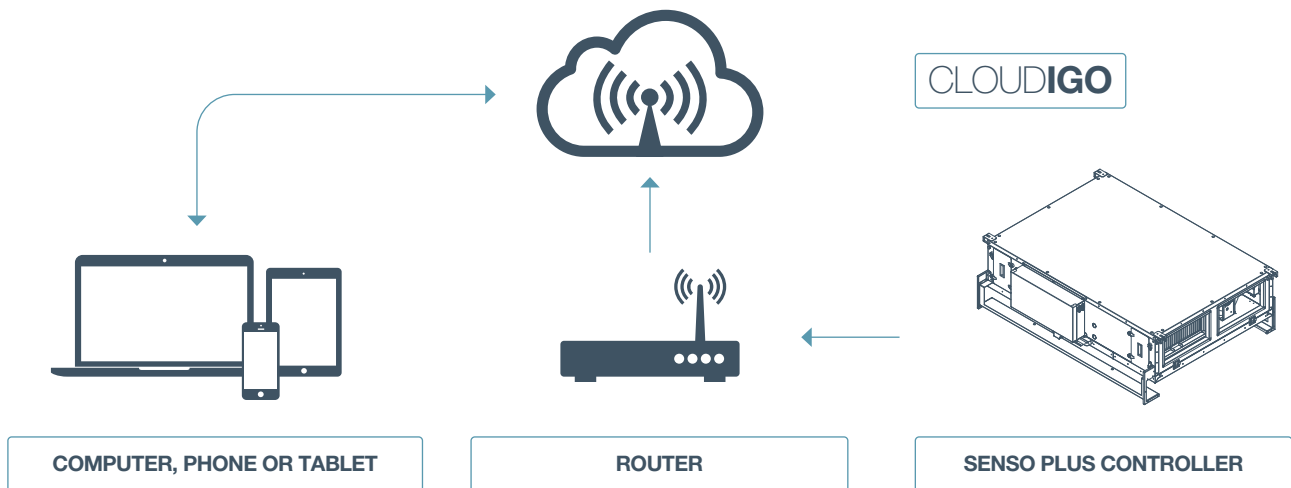



JUNE 2017 -- THE MANUFACTURER RESERVES THE RIGHT TO CHANGE THE SPECIFICATION WITHOUT PRIOR NOTICE.



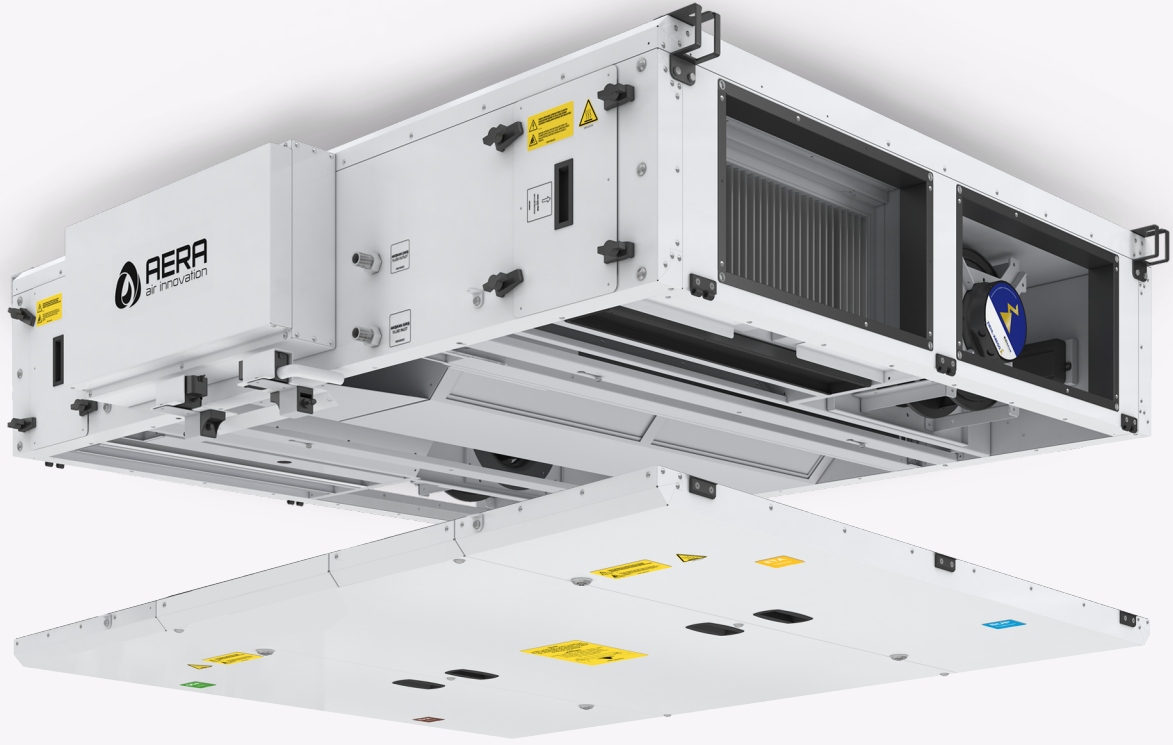

AERA İKLİMLENDİRME TEKNOLOJİLERİ SAN. VE TİC. AŞ

SALES OFFICE ■ Varyap Meridian, Grand Tower A Blok No:130 Ataşehir, İSTANBUL - TR

TEL +90 216 504 76 86 FAX +90 216 504 76 90

FACTORY ■ 3. Cadde No:13 Pancar OSB, Torbalı, İzmir - TR

TEL +90 232 799 0 111 FAX +90 232 799 01 14

R&D CENTER ■ 3. Cadde No:13 Pancar OSB, Torbalı, İzmir - TR

aera.com.tr

