

Breathing Innovation  
into Ventilation!



## EVO-MODULAR AIR HANDLING UNIT



[aera.com.tr](http://aera.com.tr)





## INDEX

ABOUT US.....	Page 4-7
ANEMO Test Lab.....	Page 8-9
CERTIFICATION.....	Page 10-11
EVO-M.....	Page 12-47

## AERA is wherever you breathe fresh!

- Offices
- Hotels
- Shopping Malls
- Industrial Buildings
- Laboratories
- Hospitals
- Nursing Homes
- Conference Halls
- Concert Halls
- Banks
- Restaurants
- Cafes
- Exhibition Halls
- Museums
- Markets
- Malls
- Schools and Universities
- Stadiums and Sports Halls
- Stations and Airports



# Inspiring Confidence, Powering Progress Globally

AERA products have achieved a global presence, captivating markets across Europe, the Middle East, and beyond.





### Welcome to AERA

### Breathing Innovation into Ventilation!

Born in the innovative surroundings of the Bilimpark – Science and Technology Development Zone, AERA started with a dedicated Product Development Team with a simple mission: to enhance air quality everywhere.

**2016** In 2016, we moved to our foundational facility in Pancar Industrial Zone. Covering over 3,000 m<sup>2</sup>, this space is equipped with modern machinery, ensuring our products meet the highest standards and reach you efficiently.

That same year, we established our domestic sales office in Istanbul, marking our commitment to serve both local and international customers.

**2017** was a pivotal year for us as we introduced our Modular Air Handling Units and Heat Recovery Ventilators to the market. By mid-2017, we began our journey towards achieving international certifications, ensuring our solutions stand up to global standards.

By the close of 2017, AERA broadened its portfolio with the introduction of the Compact Air Handling Units family. This range catered to diverse needs, including horizontal units for ceiling mounting and versatile standing units, both with plate and rotary heat recovery options.

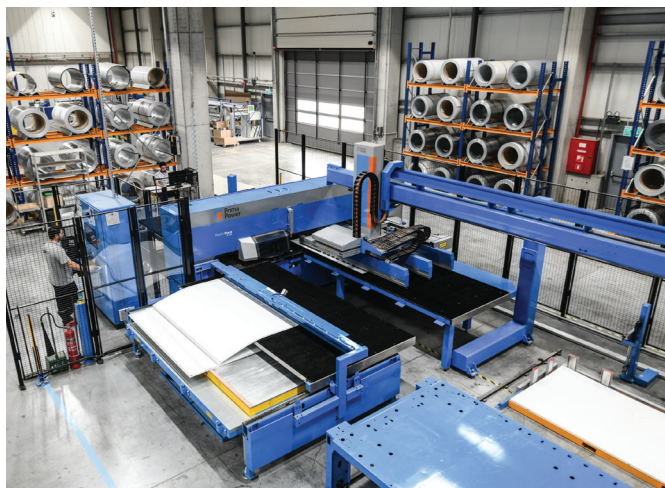

Our commitment to innovation didn't stop there. In collaboration with a leading AHU Control Components manufacturer, we co-developed distinctive air handling unit controls. These state-of-the-art controls, conceived and crafted through international expertise, made their debut in the market the very same year.

**2018** Recognizing the burgeoning industry demand and our ever-growing aspirations, 2018 was a significant milestone: We acquired a spacious factory land spanning 10,000 m<sup>2</sup>, setting the stage for further advancements and the promise of bringing even more refined ventilation solutions to our valued clientele.

The journey of AERA has always been marked by innovation and collaboration. A testament to this is our pioneering partnership with TUBITAK (Turkey's Scientific and Technological Research Council). This collaboration bore fruit in the form of our first government-subsidized development project. Our unique product designs further paved the way for us to receive State Funds, establishing our R&D Centre of Excellence.

**Our commitment to excellence was recognized globally in 2018 when EUROVENT certified our modular AHU range. This acknowledgment, particularly for outstanding casing performance (T2/TB2, EN 1886), set us apart. That year, our drive for innovation continued unabated, with the inception of development projects centered around panel casing design and ceiling-mounted air handling units equipped with rotary wheels.**



## AERA's name has grown to resonate powerfully, both within Turkish borders and beyond.

Our distinction lies not just in our products but also in our unparalleled service offerings. This has enabled us to stand tall, often being the preferred choice over renowned competitors for state-of-the-art design projects.

**2021** In a pivotal move at the end of 2021, we saw the completion of our new production plant. This state-of-the-art facility now houses the majority of our production activities and operational offices, reflecting our relentless pursuit of growth and excellence.

**2023** In the quest for healthier indoor spaces, we've made a major stride!

We are proud to announce a significant achievement in our commitment to quality and health: our Air Handling Units have earned the **Hygienic Certificate from TÜV SÜD**.



With AERA, it's always about bringing cleaner, fresher air to spaces everywhere. We're here to serve, innovate, and grow alongside our community. AERA started with a dedicated Product Development Team with a simple mission: to enhance air quality everywhere.

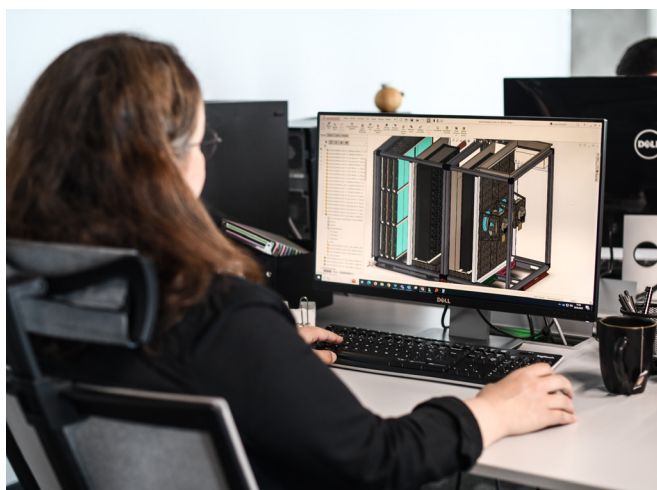

## Reference Standards

- EN 308
- EN 1886
- EN 13053
- EN 13779
- EU No 1253/2014 ECO-DESIGN
- EN 305
- ISO 5167-4:2003



**ANEMO** AERA, committed to creating energy-efficient ventilation products, has developed its products in alignment with market expectations and demands. They have implemented robust quality management and quality control systems to ensure sustainability. Beginning with customer relationship management, we have made our management philosophy traceable, measurable and transparent, including design, procurement, production and after-sales services. Internal trainings and preventive activities are performed by evaluating the harvested data and are delivered as a part of our continuous improvement policy. At AERA, every product we manufacture undergoes rigorous quality control processes, starting from the component level, and is carefully monitored at every stage of production. The air handling units undergo testing and certification by independent organizations. Additionally, tests are conducted at the ANEMO laboratory in accordance with European norms and directives, guaranteeing consistent product quality.



The logo for ANEMO testlab features a stylized circular icon on the left, composed of three curved segments. To the right of the icon, the word "ANEMO" is written in a large, bold, sans-serif font, and "testlab" is written below it in a smaller, lowercase, sans-serif font.

# ANEMO testlab

- EN 308
- EN 1886
- EN 13053
- EN 13779
- EU No 1253/2014 ECO-DESIGN
- EN 305
- ISO 5167-4:2003

## Intensive quality control

Testing what is produced not only allows us to understand the quality of the existing product but also ensures the continuous improvement of future products.

At AERA, our commitment to quality is unwavering and central to our operations. We believe in delivering nothing less than the best to our valued customers. To achieve this, we implement a rigorous 100% quality control inspection on all our finished goods, ensuring that every product meets the highest standards. Recognizing the criticality of each stage in the assembly process, we've instituted a comprehensive checklist for pre-assembly processes. Every assembled part is meticulously checked before it progresses to the subsequent station, ensuring accuracy and excellence at every juncture. By continually monitoring and recording quality data, we gain invaluable insights into our strengths and areas that require enhancement. This approach not only aligns with the best practices of the HVAC industry but also sets a benchmark, reinforcing our constant endeavor to ensure that every product delivered to our customers is of the highest quality possible.

**ECO DESIGN** All manufacturers are legally obliged to follow ECO-DESIGN directives, which are a set of the European Union's regulations that state use of energy for energy-consuming products. LOT6 of the directive reviews the ventilation devices and air handling units and is affective in the European Parliament with the EU directive number 1253/2014 and 1254/2014. The ECO-DESIGN directives, prepared by the European Council for the purpose of replacing low energy-efficient products in the market with those of high efficiency, have been accepted as a prerequisite for CE marking with the dates specified and the entry of nonconforming devices into EU countries is prohibited. Within the scope of the ECO-DESIGN directive, which has been in force since January 1st 2016, a number of sub-limit values have been defined for air handling units, such as fan, heat recovery exchanger and filter efficiency. Thermal bypass and visual monitoring of filter arresstance has become compulsory with the directive also.

**All air handling units produced at AERA are designed and manufactured according to ECODESIGN criteria**



### EUROVENT CERTIFICATION

Companies operating in the ventilation and air conditioning industry established the EUROVENT association and subsequently the association's certification body, Eurovent Certita Certification, to ensure that the performance of the units they produce can be evaluated based on common criteria, independent of local standards of countries. Today, with over 1000 members and offices in many parts of the world, EUROVENT is responsible for the certification and listing of many HVAC components such as Air Handling Units, Fan Coil Units, Roof Top Units, Chiller Units, and Air Conditioning devices through its 48 certification programs.

Air handling units are composed of components such as fans, water coils, heat recovery exchangers, filters, and humidifiers, brought together in different configurations. These components are placed inside a casing that possesses heat and sound insulation. The EUROVENT Certification program classifies the casing of the air handling unit according to the EN 1886 standard and approves thermal, acoustic, and electrical values in the data sheet created by the configuration and selection software by testing them according to EN 13053 standard.

According to EN 1886, the acoustic absorption, thermal bridging value, heat transfer coefficient, leakage values under negative and positive pressure, and deflection of the casing named MODEL BOX are measured. In EN 13053 tests, units' performance values are measured and compared with the selection data sheet. Additionally, the energy label value of the unit provided in the selection software is also approved.

**AERA Compact air handling units can be selected on [www.aerselect.com](http://www.aerselect.com) and AERA Modular Air Handling Units can be selected through AERA Modular AHU Selection software; both have been verified as a result of tests conducted by EUROVENT. Moreover, all the Model Boxes in AERA's product portfolio have been tested according to EN 1886 and their performances have been documented.**



“Sustainability is no longer about doing less harm. It’s about doing more good .”

*Jochen Zeitz*

# EVO-M

## Moduler Air Handling Unit

EVO-M Modular Air Handling Units introduce comfortable air to indoors with high energy efficiency and European Norm compatible design. Below required norms and standards are applied during the design process;



EN 1886 Ventilation for buildings. Air handling units. Mechanical performance

EN 13053 Ventilation for buildings. Air handling units.

Rating and performance for units, components and sections EN 13779 Ventilation for non-residential buildings.

Performance requirements for ventilation and room-conditioning systems

EN 308 Heat exchangers. Test procedures for establishing the performance of air to air and flue gases heat recovery devices

Commission Regulation (EU) No 1253/2014 ECO-DESIGN Requirements for Ventilation Units

EUROVENT



EVO-M Modular Air Handling Units introduce comfortable air to indoors with high energy efficiency and European Norm compatible design. Below required norms and standards are applied during the design process;

- EN 1886 Ventilation for buildings. Air handling units. Mechanical performance
- EN 13053 Ventilation for buildings. Air handling units. Rating and performance for units, components and sections
- EN 13779 Ventilation for non-residential buildings. Performance requirements for ventilation and room-conditioning systems
- EN 308 Heat exchangers. Test procedures for establishing the performance of air to air and flue gases heat recovery devices
- Commission Regulation (EU) No 1253/2014 ECO-DESIGN Requirements for Ventilation Units
- EUROVENT

## EN 1886

Air Handling units are classified according to their casing performance with the European Norm; EN1886. Testing and classification procedures are explained in the standard.

CASING CLASSIFICATION ACCORDING TO EN 1886							
EVO	TEST CRITERIA						
Casing Mechanical strength	D1	<b>Mechanical Strength Class</b>	D1		D2		D3
		Maximum Relative Deflection $\text{mm} \times \text{m}^{-1}$	4		10		exceeding 10
Casing Air Leakage Negative Pressure -400Pa	L1	<b>Air Leakage Class</b>	L1		L2		L3
		Maximum Leakage ( $f_{400}$ ) $\text{l} \times \text{s}^{-1} \times \text{m}^{-2}$	0.15		0.44		1.32
Casing Air Leakage Positive Pressure +700Pa	L1	<b>Air Leakage Class</b>	L1		L2		L3
		Maximum Leakage ( $f_{700}$ ) $\text{l} \times \text{s}^{-1} \times \text{m}^{-2}$	0.22		0.63		1.90
Filter bypass leakage	F9	<b>Filter Leakage Class</b>	F9	F8	F7	F6	G1-F5
		Filter by pass leakage rate	0.50	1	2	4	6
Thermal transmittance	T2	<b>Thermal transmittance class</b>	T1	T2	T3	T4	T5
		Thermal Transmittance (U) $\text{W} \times \text{m}^{-2} \times \text{K}^{-1}$	$U \leq 0.5$	$0.5 < U \leq 1$	$1 < U \leq 1.4$	$1.4 < U \leq 2$	Non standard
Thermal bridging	TB2	<b>Thermal Bridging Class</b>	TB1	TB2	TB3	TB4	TB5
		Thermal bridging function (kb)	$0.75 < kb \leq 1$	$0.6 < kb \leq 0.75$	$0.45 < kb \leq 0.6$	$0.3 < kb \leq 0.45$	Non standard

### Mechanical Strength of the casing

The mechanical strength of the casing is indeed the strength of the structural construction of an AHU. The classification of this parameter is based on the deflection of the panels and frames of the air handling unit. During the tests, the unit is subjected to an internal positive of 1000 Pa and then to an internal negative pressure of 1000 Pa. In both cases deflections shall be measured.

Then the unit is subjected to higher pressures, in order to withstand the max. fan pressure without permanent deflection (is considered permanent deflection for values  $>2\text{mm}$ ), to an internal positive of 2500 Pa and then to an internal negative pressure of 2500 Pa. Once again all the deflections shall be measured.

Casing Strength	Maximum Relative Deflection [ $\text{mm} \times \text{m}^{-1}$ ]
D 1	$<4$
D 2	$<10$
D 3	$> 10$

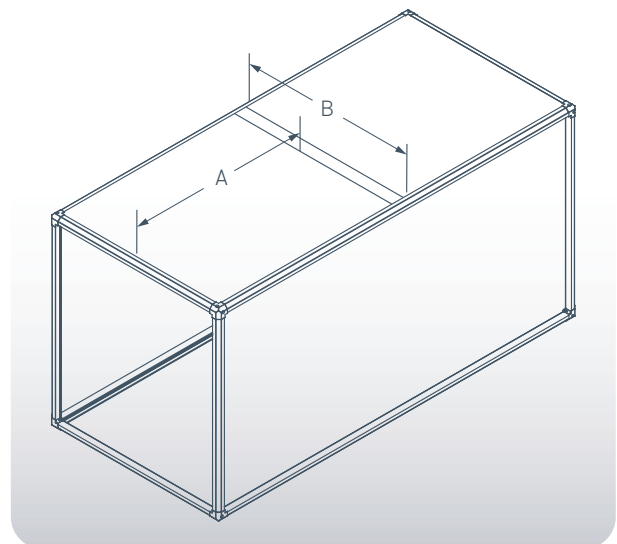

### Casing Air Leakage

This is a key parameter to understand for one hand if all the energy consumption used in the fan is used to generate the exact airflow of the operation set-point, and on the other hand to understand if we have infiltration of non-handling air inside the AHU. The casing air leakage test is performed after the mechanical strength test. It performed by subjecting the unit to an internal negative pressure of 400 Pa, measuring the leakage rate through the casing. Then the same procedure is repeated but now subjecting the unit to an internal positive pressure of 700 Pa, and leakage rate shall be measured.

Casing Air Leakage @ + 700 Pa	
Leakage Class	Maximum leakage rate ( $f_{700}$ ) ( $l \times s^{-1} \times m^{-2}$ )
L3	1,9
L2	0,63
L1	0,22

Casing Air Leakage @ + 400 Pa	
Leakage Class	Maximum leakage rate ( $f_{400}$ ) ( $l \times s^{-1} \times m^{-2}$ )
L3	1,32
L2	0,44
L1	0,15

### CASING AIR LEAKAGE TEST APPARATUS

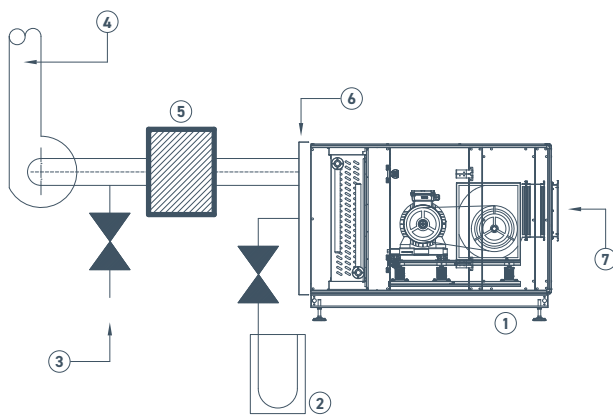

- 1. AHU under test
- 2. AHU test pressure gauge
- 3. Bleed valve as alternative to variable speed fan
- 4. Variable Speed Fan
- 5. Air Flow Measurement
- 6. Inlet Plate
- 7. Outlet Plate

### Filter by-pass leakage

Because of the leakages through the internal design of the filter assembly, the filter of the unit may not be performing as its specification. This criteria is especially important for buildings with high IAQ demands, for example hospitals and laboratories. In the filter bypass leakage test, the unit is subjected to an internal positive and negative pressure of 400 Pa

### LEAKFREE FILTER SLIDING SYSTEM

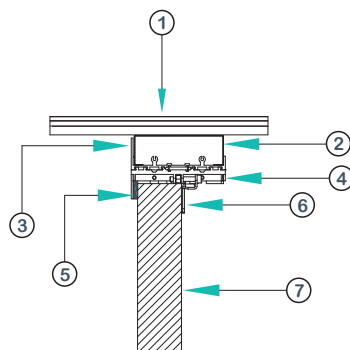

- 1. Top Panel
- 2. Filter top connection part
- 3. Male Aluminum Tray
- 4. Female Aluminum Tray
- 5. Sealing
- 6. Compression Mechanism
- 7. Filter

### FILTER BY-PASS LEAKAGE TEST APPARATUS

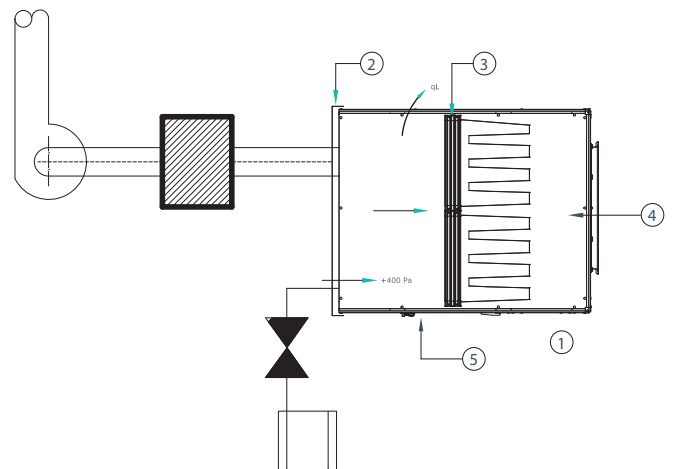

- 1. Test Unit
- 2. Inlet Plate
- 3. Filter cells and sealed filter frame
- 4. Filter section
- 5. Casing

## Thermal Transmittance

Air Handling Units are sized in heating/cooling capacity by neglecting the losses from the casing. Especially for the outdoor installations, according to the temperature difference between the supplied air and outdoor air, significant losses may happen with poorly designed casings. EVO product family is designed with 50 mm Mineral Wool insulated panels to reduce the thermal leakage from the casing. Adequate design is carried out for weakest surfaces like corners, locks and hinges and duct connection panels.

Thermal transmittance is measured and calculated with 20K temperature difference between the outdoor air and inside the unit.

## Thermal Bridging of the casing

Because of the thermal losses in an air handling units components like section connections, structural profiles, doors and hinges, casing corners and panel internal/external sheet metal, the installation properties of the casing can not be homogenous through the whole casing. Places such of those where the insulation properties are reduced are called the Thermal Bridges. If the Thermal Bridges can not be avoided, there will be significant amount of heat loss and condensaiton will occur on these surfaces damaging Air Handling Units casing.

The test is performed in conditions when the difference in average temperature between the interior and exterior temperatures is steady at 20 K. The point at the highest temperature on the outer surface of the casing shall be measured. The ratio between the difference between the interior average air temperature and the maximum external surface temperature and the average temperature difference between the air on the interior and exterior of the unit determines the thermal bridge factor.

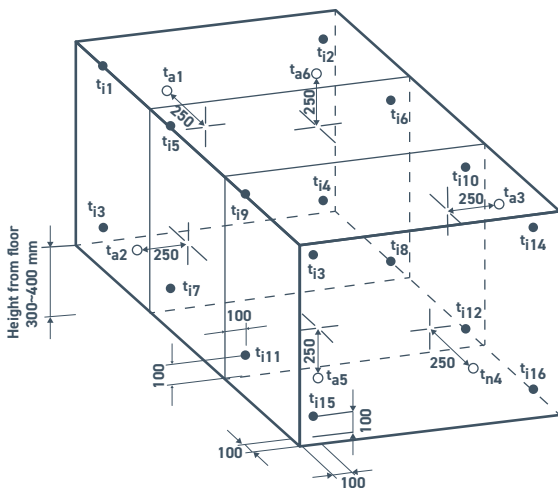

$$k_b = \frac{T_i - t_{smax}}{t_i - t_a}$$

$$k_b = \Delta t_{min} / \Delta t_{air}$$

Where:

$\Delta t_{min}$ : is the smallest temperature difference,  
 $\Delta t_{min} = t_i - t_{smax}$

$\Delta t_{air}$ : Temperature difference between the interior and exterior air,  $\Delta t_{air} = t_i - t_a$



Below rendered psychometric chart presents the outdoor air conditions where condensation will start in an Air Handling unit with different Thermal Bridging classes. From the diagram it can be read that for an outdoor air temperature of -12°C inside the unit casing and 24°C installation space, condensation will not start before 18%RH for TB4, 28%RH for TB3, 40% for TB2 and 57% for TB1.

- TB4 (kb=0,30) 24°C, 18 % r. h.
- TB3 (kb=0,45) 24°C, 28 % r. h.
- TB2 (kb=0,60) 24°C, 40 % r. h.
- TB1 (kb=0,75) 24°C, 57 % r. h.

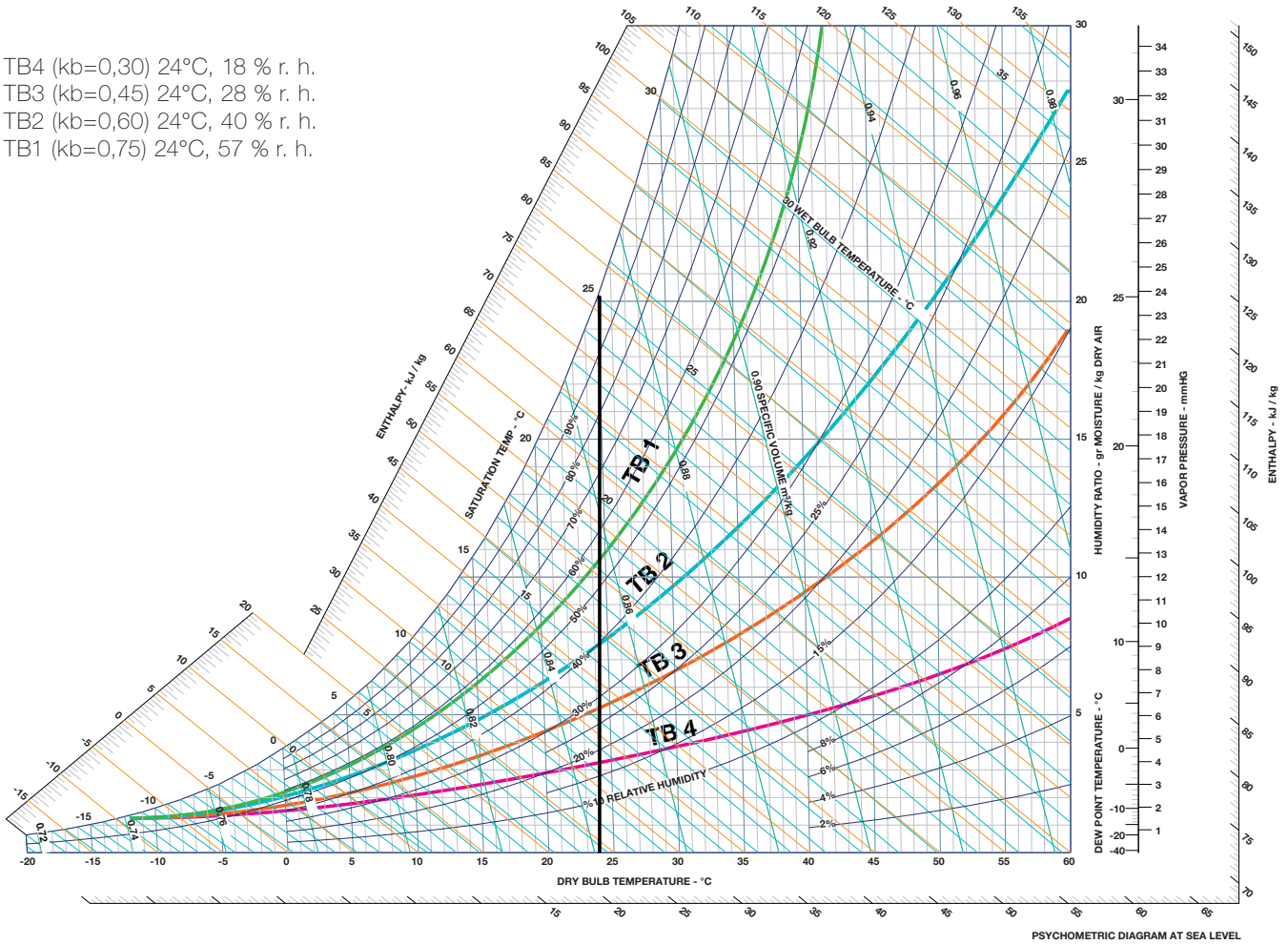

### Acoustic Insulation of the Casing

Casing of an air handling units not only helps to reduce the thermal and air leakages but also reduces the transferred sound from the casing to the supplied air. The sound insulation of the casing is named as the Transition Loss and measured for 1/3 Octave Band and listed in the casing specifications.

All manufacturers are legally obliged to follow ECO-DESIGN directives, which are a set of the European Union's regulations that state use of energy for energy-consuming products. LOT6 of the directive reviews the ventilation devices and air handling units and is effective in the European Parliament with the EU directive number 1253/2014 and 1254/2014. The ECO-DESIGN directives, prepared by the European Council for the purpose of replacing low energy-efficient products in the market with those of high efficiency, have been accepted as a prerequisite for CE marking with the dates specified and the entry of non-conforming devices into EU countries is prohibited.



Within the scope of the ECO-DESIGN directive, which has been in force since January 1st 2016, a number of sub-limit values have been defined for air handling units, such as fan, heat recovery exchanger and filter efficiency. There are also directives concerning the operation of the air handling unit.

## ECO-DESIGN Application Criteria

For which applications does the ECO-DESIGN directive apply?	The Directive has been created for ventilation devices and air handling units where some or all of the air contaminated by human activity or building emissions in the interior is replaced by fresh air from outside.
Device Classification	Residential Ventilation Equipments (RVU) $Q_{max} \leq 250 \text{ m}^3/\text{h}$ Non-Residential Ventilation Devices (NRVU) $Q_{max} > 250 \text{ m}^3/\text{h}$ Residential Ventilation Devices (RVU) * $1000 \text{ m}^3/\text{h} > Q_{max} > 250 \text{ m}^3/\text{h}$
Implementation Schedule	Tier 1: January 1, 2016 Tier 2: January 1, 2018
Unit Exceptions	<ul style="list-style-type: none"> <li>■ Agricultural ventilation applications</li> <li>■ Transportation applications</li> <li>■ Exhaust hoods in industrial kitchens</li> <li>■ Fresh air or exhaust devices with a power consumption of 30 W or less and a one-way airflow</li> <li>■ Bi-directional flow devices with a power consumption of 30 W or less for each fan</li> <li>■ Axial or radial fans in a body according to EU 327/2011</li> <li>■ Fans operating in explosive atmosphere</li> <li>■ Emergency fans</li> <li>■ Fans operating at very high or very low temperatures</li> </ul>

\* In cases where the manufacturer states that it is for residential use.

### Unidirectional Ventilation Units (UVU)

The model device is defined in the directive as follows.

- Airflow is one-way (supply or exhaust only).
- On the inlet side there is a class F or better filter.
- There are one or more fans in the same air line inside the device.

In the Directive, the limit value for minimum fan efficiency and  $SFP_{int}$  is specified as follows.

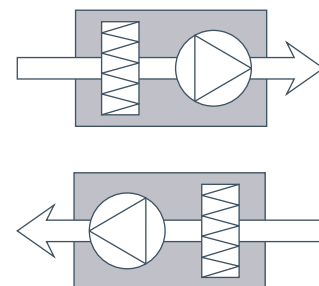

		ErP 2016	ErP 2018
Minimum Fan Efficiency $\eta_s$ (%)	$P \leq 30$ kW	$6,2 \times \ln(P^*) + 35$	$6,2 \times \ln(P) + 42$
	$P > 30$ kW	56,1	63,1
The maximum allowed $SFP_{int}$ [W/(m <sup>3</sup> /s)] value for the model device		250	230
Variable speed drive requirement		Yes	Yes
Obligation to monitor pressure drop for filters		No	Yes

\* Nominal Effective power supply at nominal external pressure and air flow, including electric power supply (kW), fan motors and drives of motors.

### Bidirectional Ventilation Units (BVU)

The model device is defined in the directive as follows:

- Airflow is bidirectional (with supply air and exhaust)
- There is a class F on the supply air side and a class M filter on the exhaust side.
- The unit has a heat recovery system.

In the Directive, the limit value for minimum fan efficiency and  $SFP_{int}$  is specified as follows:

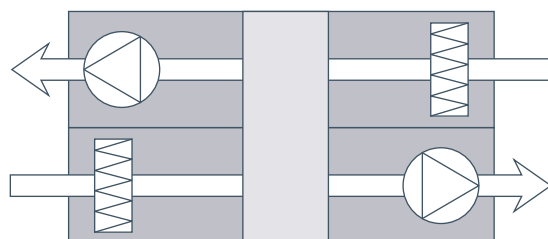

		ErP 2016	ErP 2018
Heat recovery system with thermal by-pass mandatory		Yes	Yes
Thermal Efficiency (EN308)* $\eta_t$ [%]	Plate / Rotary HR	67	73
Maximum allowed $SFP_{int}$ value for model device	Plate / Rotary HR	$q^{*2} < 2\text{m}^3/\text{s}$	$1.200 + E - 300 \times q / 2 - F$
		$q \geq 2\text{m}^3/\text{s}$	$900 + E - F$
HR efficiency add-on, E	Plate / Rotary HR	$(\eta_t - 67) \times 30$	$(\eta_t - 73) \times 30$
Filter correction coefficient, F	Model Unit	0	0
	No M filter	160	150
	No F filter	200	190
	No M + F filter	360	340
Variable speed drive requirement		Yes	Yes
Obligation to monitor pressure drop for filters		No	Yes

\*1 EN 308 conditions are internal and external weather conditions where condensation has not occurred and should be taken as follows. **OUTDOOR AIR CONDITIONS:** 5 °C **ROOM CONDITIONS:** 25 °C, 28 % RH

\*2 Air flow at the working point of the device (m<sup>3</sup>/s)

## SFP<sub>int</sub> Value and Calculation Method

According to EN 13779, the SFP is calculated as the ratio of the fans of the air supply unit provided by the unit.

In ECO-DESIGN directives, the SFP value is redefined as SFP<sub>int</sub>. The SFP<sub>int</sub> value relates to the performance of the components used in the design of the device, and does not take the ducting system inefficiencies into consideration. This provides a more accurate comparison between units. The internal losses to be taken into account in the SFP<sub>int</sub> calculation are pressure losses in the heat recovery exchanger, filter and housing.

Sample Calculator: The table below shows the operating point for the internal pressure drops in a heat recovery ventilator. The SFP value is compared with the SFP<sub>limit</sub> value specified in the ECO DESIGN criteria, calculated by these values and fan efficiencies. If the SFP interior is smaller than the SFP<sub>limit</sub> the device meets the ECO DESIGN criteria.

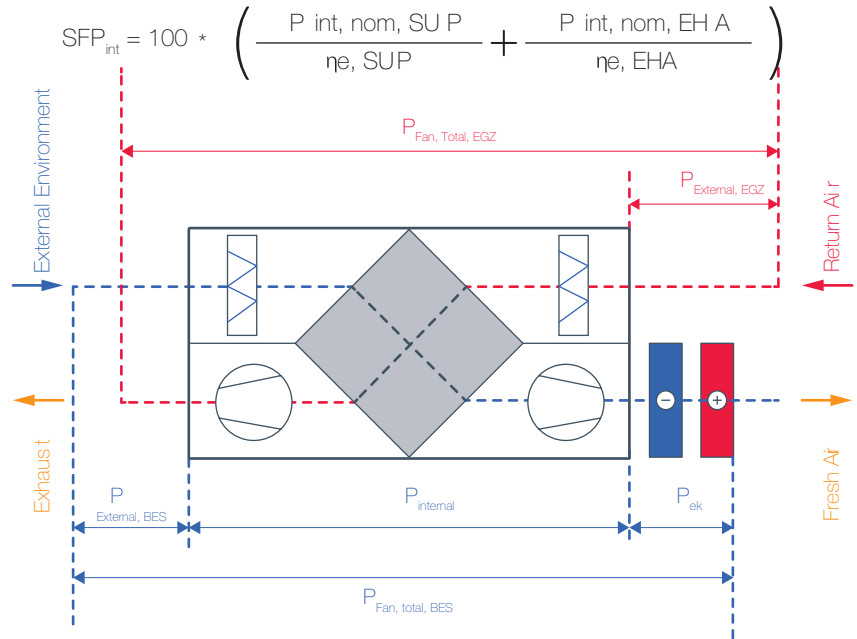

	Intra-device pressure loss [Pa]				External Static pressure (Pa)	Fan efficiency at the operating point (including external static pressure)	SFP <sub>int</sub>
	HR Exchanger	Supply Air Filter (F7) Exhaust Air Filter (M5)	System Loss	Total			
Supply Air	179	109.97	44.75	333.72	100	0.596	559.9
Exhaust Air	180	90.86	44.75	315.61	100	0.596	529.5
<b>SFP<sub>int</sub>, total</b>							<b>1089.5</b>

Filter Correction Factor, F	M5 and F7 filter	0
HRE efficiency addition, E	(η <sub>t</sub> -0.67)*3000	30
<b>SFP<sub>ie</sub>, limit<sup>(2016)</sup></b>	<b>1200 + E - 300 * q<sub>nom</sub> / 2 - F</b>	<b>1146.66</b>

Where the ventilation unit is not designed for a single operating point, compliance with the ECO-DESIGN directive should be indicated on the unit operating curves. The following chart shows an ECO-DESIGN performance curve for an air handling unit with variable airflows.

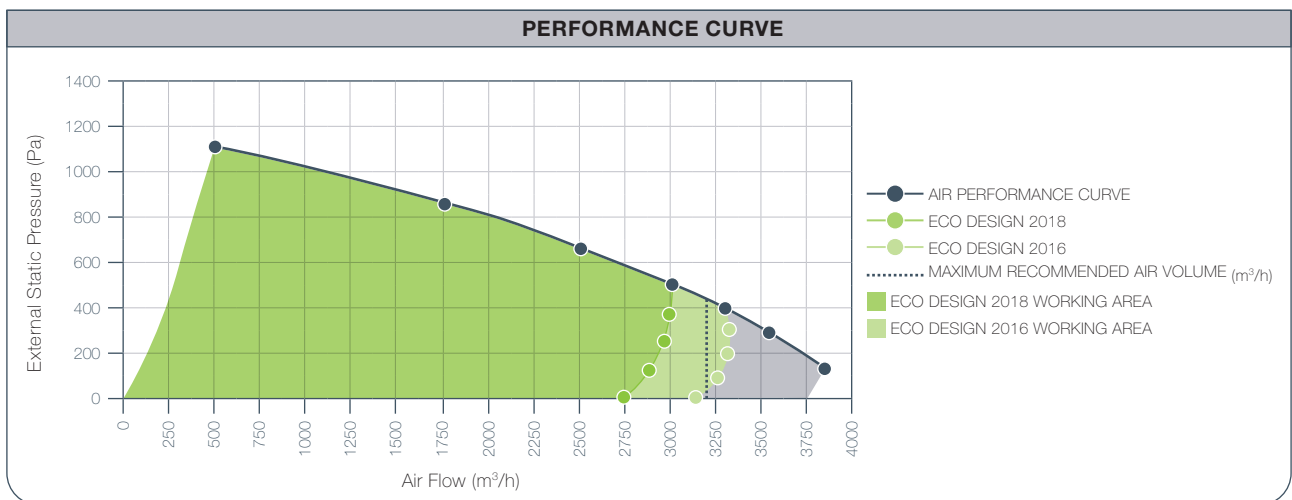

## EUROVENT

Eurovent is an organization set up by leading European Air Handling Unit Manufacturers to ensure fair comparison and fair competition. In accordance with the sampling program, the air handling units and components are correctly classified using the performance information obtained in tests conducted in independent test laboratories.



At the beginning of the certification program, the unit, which is requested by the certification committee, is produced by the supplier, the unit is sent to the test and the casing and performance values are reported. According to the manufacturer's Quality certificates, the tests are repeated every year or every 3 years. Thus, the accuracy of the catalog data of the products and the results of the selection software are checked within tolerances and an attempt is made to create a trust environment within the market.

ENERGY CLASSIFICATION TABLE				
CLASS	ALL UNITS	UNITS FOR FULL OR PARTIAL OUTDOOR AIR AT DESIGN WINTER TEMPERATURE $\leq 9^{\circ}\text{C}$ .		FAN EFFICIENCY LEVEL NGref-class [-]
	VELOCITY class [m/s]	HEAT RECOVERY SYSTEM (HRS)		
		$\eta_{\text{class}}$ [%]	$\Delta p_{\text{class}}$ [Pa]	
A+ / A+↻ / A+↑	1.4	83	250	64
A / A↻ / A↑	1.6	78	230	62
B / B↻ / B↑	1.8	73	210	60
C / C↻ / C↑	2.0	68	190	57
D / D↻ / D↑	2.2	63	170	52
E / E↻ / E↑	No calculation required			Not required

CLASS	CLASSIFICATION SYMBOL	CLASSIFICATION PARAMETERS
Units for full or partial outdoor air at design winter temperature $\leq 9^{\circ}\text{C}$ .	A + ..... E	Face Velocity
		Heat Recovery Efficiency
		Heat Recovery Pressure Drop
		Fan Efficiency
Recirculation units or units with design inlet temperatures always $> 9^{\circ}\text{C}$ .	A + ↻ ..... E ↻	Face Velocity
		Fan Efficiency
Stand-alone extract air units.	A + ↑ ..... E ↑	Face Velocity
		Fan Efficiency

The following steps should be taken while calculating the class of the air handling unit;

- It is assumed that the air handling unit belongs to a class and the values belonging to this class are noted in the table.
- For the design working point, the fan static pressure increase, external static pressure loss, cross-sectional speed, fan power and, if the unit belongs to subgroup 1, the HRS heat recovery exchanger efficiency and pressure drop are calculated.
- Depending on the velocity, the pressure correction factors  $\Delta P_x$  is calculated if it belongs to subgroups 1 then  $\Delta P_y$  and  $\Delta P_z$  are additionally calculated.
- The reference power consumption (Pair side-ref) for the associated air line (fresh air or exhaust) is calculated.
- Finally, the reference power consumption factor (fs-Pref) is calculated. If this value is equal to 1 or smaller, the unit meets the requirements of the first accepted class. If it is greater than 1, the same procedure should be repeated by adopting a lower subclass.

## Pressure correction due to velocity; $\Delta p_x$

$$\Delta P_x = (\Delta P_{s-dahili} - \Delta P_{s-HRS}) * \left\{ 1 - \left( \frac{V_{sinif}}{V_s} \right)^{1.4} \right\}$$

- $\Delta P_{s-internal}$  =  $\Delta p_{s-static}$  -  $\Delta p_{s-external}$  internal pressure drop across components; exclusive system effect pressure drops [Pa]  
 $\Delta P_{s-static}$  = useful fan static pressure increase measured between fan inlet and fan outlet [Pa]  
 $\Delta P_{s-external}$  = external (ductwork system) pressure drop [Pa]  
 $\Delta P_{s-HRS}$  = HRS pressure drop [Pa] (0 if no HRS or subgroup 2 or 3)  
 $V_{class}$  = value from Table 2 [m/s]  
 $V_s$  = velocity in AHU filter (fan if no filter) cross section [m/s]

## Pressure correction due to HRS pressure drop; $\Delta p_y$

$$\Delta P_y = \Delta P_{s-HRS} - \Delta P_{class}$$

- $\Delta P_{s-HRS}$  = HRS pressure drop (0 if no HRS or subgroup 2 or 3) [Pa]\*  
 $\Delta P_{class}$  = value from Table 2 [Pa] (0 if subgroup 2 or 3)

## Pressure correction due to HRS efficiency; $\Delta p_z$

$$\Delta P_z = (\eta_{class} - \eta_s + 5 * cf_{heater}) * \left( 1 - \frac{mr}{100} \right) * f_{pe}$$

- $\eta_s$  = HRS dry efficiency winter [%] (0 if no HRS or subgroup 2 or 3)  
 $\eta_{class}$  = value from Table 2 [%] (0 if subgroup 2 or 3)\*  
 $mr$  = mixing ratio, winter (recirculation air / supply air; maximum), allowed range 0 to 85 [%]  
 $f_{pe}$  = pressure – efficiency factor  
 =  $(- 0.0035 * t_{ODA} - 0.79) * t_{ODA} + 8.1$  [Pa / %]  
 $t_{ODA}$  = design outdoor temperature, winter [°C]  
 $cf_{heater}$  = correction for electrical heater (reheater, i.e. heater downstream the HRS).  
 = 0 when there is no electrical heater  
 = 1 when there is an electrical heater

\* (Eğer HRS bilgisi yoksa veya altgrup 2 veya 3 ise 0 alınacaktır)

## Fan reference power

$$P_{air\ side-ref} = \frac{[\Delta P_{s-static} - (\Delta P_x + \Delta P_y + \Delta P_z)] * q_{v-s}}{a * \ln(P_{air\ side-ref}) - b + NG_{ref}}$$

- $P_{air\ side-ref}$  = fan reference power [kW] (use  $P_{sup-ref}$  for supply air side  $P_{ext-ref}$  or extract air side)  
 $q_{v-s}$  = air volume flow rate [m<sup>3</sup>/s]  
 $NG_{ref}$  = Fan Efficiency Grade corresponding to the class value (see Table 2)  
 $a, b$  = coefficients as per Table 3 below.

$P_{air\ side-ref}$	a	b
≤ 10 kW	4.56	10.5
> 10 kW	1.1	2.6

## Absorbed power factor; $f_{s-Pref}$

The values from the calculations made in the previous steps are used in the following formula. If the result is less than or equal to 1, the unit meets the requirements of the accepted energy class, otherwise the same procedure must be repeated by adopting a lower subclass.

$$f_{s-Pref} = \frac{P_{s-bes} + P_{s-emş}}{P_{bes-ref} + P_{emş-ref}} \leq 1$$

- $f_{s-Pref}$  = absorbed power factor  
 $P_{s-sup}$  = active power supplied from the mains, including any motor control equipment, to selected supply air fan [kW]  
 $P_{s-ext}$  = active power supplied from the mains, including any motor control equipment, to selected extract air fan [kW]  
 $P_{sup-ref}$  = supply air fan reference power [kW]  
 $P_{ext-ref}$  = extract air fan reference power [kW]

**VDI 6022**

- Sealing materials in air-handling areas shall be closed-pored; they shall not absorb any humidity or release any odours and, in particular, must not provide a nutrient substrate for microorganisms.
- In order to avoid microbiological growth, it must be ensured that the relative humidity is not higher than 80% in areas where filters and silencers are present. Humidifiers must not be placed in front of silencers or filters.
- The materials, the design of surfaces and geometrical shaping of the system components shall be such as to prevent the adhesion and depositing of contaminations.
- All components must be accessible for the purposes of the required inspection and cleaning work
- Ensure that there are no humid areas in the humidifier and cooler outlets during shut downs longer than 48 hours. For this purpose, humidifiers and coolers must be switched off beforehand and dry air should circulate through the system (gradual shut down).
- Units with an inside height of 1.3 m and above are required to have a monitoring glass for all humidifiers, fans and air filters. In addition to this lighting inside is recommended.
- As a matter of principle, only such air filters shall be used for air filtration in ventilating and air-conditioning systems and in air-handling units, which have been tested in accordance with EN 779 or EN 1822, and which are labelled individually
- The drain pan must be made of corrosion-resistant material inclined from each side. The drain line should not be connected directly to the waste water line.
- Air filters should be replaced from dust-filled side. Filters should not be flat on the unit floor. The pouches of the bag filters should always be placed in vertical position.
- Independent of other indicators; Each filter stage of the air handling units in which the volumetric air flow is more than 1000 m<sup>3</sup> / h must be fitted with a differential pressure gauge in the correct operating range to instantly show the pressure losses of the air filters.
- If a belt driven fan is used (except flat belts) a filter stage should be added after the fan.

## EN 13053: Ventilation for buildings - Air handling units - Rating and performance for units, components and sections

The performance tests of air handling units and components and the classification of velocity, total power consumption and system energy efficiency in the unit are made according to EN 13053 standard.

CLASSES OF AVERAGE AIR VELOCITY LEVELS INSIDE THE CASING			
CLASS	AIR VELOCITY (m/s)		
V1	≤ 1.6	Note: The air velocity in the unit has a large influence on energy consumption. The velocities are calculated for air velocity in AHU cross-section. The velocity is based on the square area of filter section of a unit, or if no filter is installed it is based on the square area of the fan section.	
V2	> 1.6 to 1.8		
V3	> 1.8 to 2.0		
V4	> 2.0 to 2.2		
V5	> 2.2 to 2.5		
V6	> 2.5 to 2.8		
V7	> 2.8 to 3.2		
V8	> 3.2 to 3.6		
V9	> 3.6		
CLASSES OF POWER INPUT OF DRIVES (FANS)			
CLASS	Pm maximum (kW)		
P1	≤ Pm ref x 0.85	The electrical power consumption depends on the air flow of the fan and the increase in static pressure. Pressure losses in the fan housing and on the diffuser plate are not regarded as static pressure increases, but as fan losses separately.	
P2	≤ Pm ref x 0.90		
P3	≤ Pm ref x 0.95	$P_{m\ ref} = \left( \frac{\Delta P_{stat}}{450} \right)^{0.925} * (q_v + 0.8)^{0.95}$ <p> <math>P_{m\ ref}</math> [kW] reference power input  <math>\Delta P_{stat}</math> [Pa] sstatic pressure at the fan section  <math>q_v</math> [m<sup>3</sup>/s] air flow                 </p>	
P4	≤ Pm ref x 1.00		
P5	≤ Pm ref x 1.06		
P6	≤ Pm ref x 1.12		
P7	> Pm ref x 1.12		
HEAT RECOVERY CLASSES			
CLASS	Energy efficiency $\eta_{e1:t}$		
H1	≤ 71	$\eta_e = \eta_t \times \left( 1 - \frac{1}{\epsilon} \right)$ <p> <math>\eta_e</math> [%] Energy Efficiency  <math>\eta_t</math> [%] Thermal efficiency under dry conditions  <math>\epsilon</math> [-] Performance Coefficient                 </p>	
H2	≤ 64		
H3	≤ 55	If supply air and exhaust air flows are not equal and no information is available on efficiency, the efficiency is calculated using the following empirical formula.	
H4	≤ 45		
H5	≤ 36		
H6	-		
		$\eta_t = \eta_{t\ 1:t} \times \left( \frac{\text{Exhaust air flow}}{\text{Fresh air flow}} \right)^{0.4}$	

■ The filter pressure losses during design should be calculated by taking the arithmetic mean of the initial and final pressure losses. The final pressure drops according to the filter classes are indicated in the standard with the following values.

G1 - G4: 150 Pa  
 M5 - F7: 200 Pa  
 F8 - F9: 300 Pa



The air handling units produced in our company are tested and certified by independent organizations and also subjected to tests in the AERA-ANEMO laboratory in order to carry out the design verification procedures. The ANEMO laboratory, which is designed in accordance with the European Norms and Directives used, carries out tests according to the following criteria;

- EN 308 Heat exchangers-Test methods for determining the performance of heat recovery devices from air to air and waste gases
- EN 1886 Ventilation for Buildings - Air Handling Units - Mechanical Performance
- EN 13053 "Air handling units - Classification and performance for devices, components and cells"
- EN 13779 "Performance requirements for ventilation and room conditioning systems"
- European Union Energy Commission (EU) No 1253/2014 "ECO-DESIGN requirements for ventilation equipment"
- EN 305 "Performance specifications for heat exchangers and test procedures for performance measurement"
- ISO 5167-4: 2003 "Flow measurement with differential pressure measurement devices placed in circular cross-section pipes - Part 4: Venturi pipes"

For air performance tests, two sealed and isolated volumes are used for indoor and outdoor conditions. The thermal efficiency and capacity tests of air handling units and air performance tests can be carried out in 5200 m<sup>3</sup> / h air flow and -20°C outside and +37°C indoor conditions.

Precision measurement equipment and data acquisition software are used for determining the thermal and mechanical performance of the unit such as efficiency, thermal bridging, thermal transmittance and air leakage.

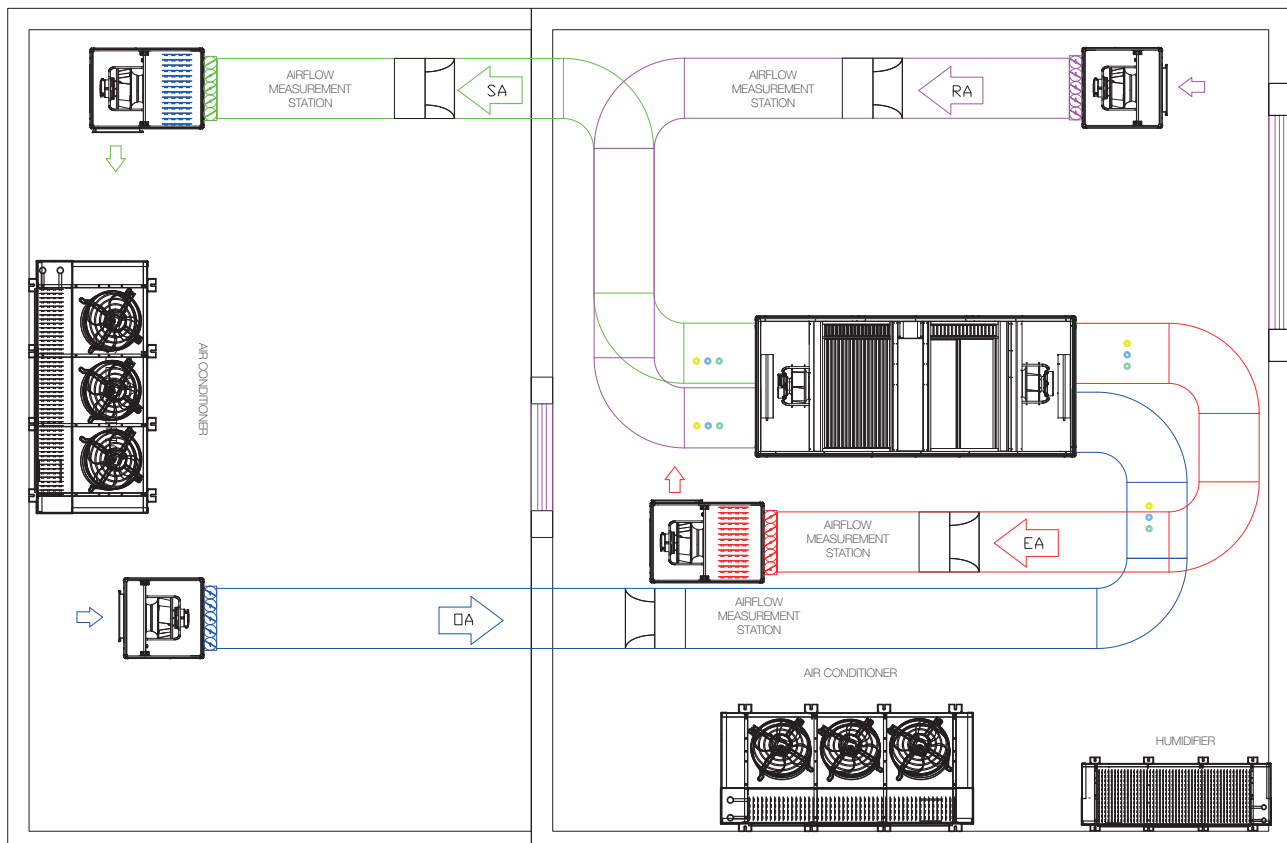

All of the equipment used during the test is periodically checked and calibrated by the accredited institutions. The main test and auxiliary equipment found in the ANEMO laboratory;

- Sensors (Temperature, relative humidity, differential pressure)
- Venturi tube
- Energy analyzer
- Data acquisition device and software
- Leak test system
- Sound measuring station
- Air conditioning system

Selection Software developed by our company is used to provide the supply air conditions and component requirements determined in the projects. The sections containing all the components that may be present in the air handling units are defined in the selection software and are designed according to the configuration desired in the project.

The selection software is web-based, this makes it possible to access it from anywhere with a username and password. Previously made selections are stored in the user specific database, the old projects can be examined and reproduced and used for new projects, if desired, can be sent to another user.

## ADVANTAGES OF AERA SELECT

- The calculations for heating, cooling, humidification / dehumidification, sound attenuation, heat recovery, suction or blowing, filtering and air mixing are automatically made with user inputs, the necessary components are selected and the performance values of the EVO Modular Air Handling Units with the details are presented with a report to the user.
- After creating the required configuration from the AERA Selection software, the user can obtain performance values at the new operating points of the unit by simulating the increase / decrease of the external pressure or the air flow by simulating how the device will work at another operating point.
- The physical constraints at the installation site can be defined by selecting the appropriate unit before installation by configuring the program before manufacturing.
- AERA Selection Software contains measures against user-induced selection or configuration errors.
- In addition to the classic belt driven fans, there are also external motor plug fans and direct drive EC plug fans can be selected from the software. EC Plug fans can be easily installed in the Fan Array application, which significantly reduces the unit size, reduces noise levels and simplifies service.
- The selection reports are prepared according to Eurovent criteria and contain all necessary information including energy class. ECO-DESIGN calculations, which have become an important criterion in determining the performance of the device today, are also performed for the selected device, and the values and conformity reached are indicated on the report.
- It has a simple and plain interface that can be easily learned, different units in the project are selected quickly and their technical and price information are reported.
- In addition to the performance values of EVO Modular Air Handling Units, price information are also extracted as proforma invoice from the selection software.
- The detailed technical drawings of the EVO Modular Air Handling Unit selected according to the needs of the project are provided in DXF format.

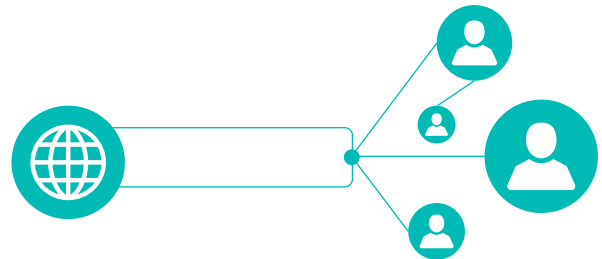

Components such as coils, exchangers, etc. may cause prolonged delivery times of air handling units. As a part of AERA's rapid delivery policy, such components are kept in stock at the capacity values used frequently. In the selection software, the components with stock are shown to the user. If the unit configuration is formed with these components, the selected EVO Modular Air Handling Unit is produced with quick delivery option.

Selection Filters					
Minimum Recovery Efficiency:		50 %		Maximum Pressure Drop:	
Fast Deliv.	Model	Balanced		Supply	
		Efficiency	Pressure Drop	Efficiency	Temp
		%	Pa	%	
	W2000/200/017	68.9	178.0	71.2	15.
	W1900/200/017	66.9	198.0	69.1	14.
	W1800/200/017	64.6	221.0	66.7	14.
	W2000/200/020	63.0	126.0	64.8	14.
	W1900/200/020	60.4	141.0	62.3	13.
	W1800/200/020	57.8	158.0	59.6	13.
	W1700/200/020	54.9	178.0	56.6	12.
	W2000/200/025	53.3	87.0	54.9	12.

# CASING DESIGN

EVO Modular Air Handling Unit's casings are engineered with today's standards, according to future needs. By eliminating the defects of traditional casings, high thermal and acoustical performance have been achieved, mechanical strength and corrosion resistance have been increased. As a result, a compact body that provides easy operation and service has emerged.

Performance values were calculated prior to the actual product testing, using modern engineering methods developed by 3D computerized design and analysis during design stage. Subsequently, these values were verified with tests made in accordance with relevant standards in our modern testing laboratory.

## LOW THERMAL BRIDGING DESIGN

### PVC Frame

In EVO Modular Air Handling Units, unique panels with high thermal and air leakage resistance are used in fixed panels and service panels. Continuity is provided in the seals by special corner joining method.

The panels to prevent the formation of thermal bridging are made up of sheet metals and sealing gaskets that are fixed on a specially designed PVC frame. Since the inner and outer panel sheets are not connected, thermal bridging from metal surfaces is prevented.

With the help of the PVC frame used, continuous and homogeneous insulation was obtained on the panels. With this structure on the sides of the panel, the thickness remain the same for each surface. The air gap in the PVC profile increases the thermal resistance of the profile and reduces the total heat transfer coefficient.

### Unit Components

The components that may cause thermal bridging due to the connection between the inner and outer air flow in the central body are locks and hinges and similar connection components. This connection is evaded by connecting all components externally and a seamless insulation is provided on the casing.

### PANEL

Unit's panels are made of sheet coated with high corrosion resistant stainless steel. The outer surface is made of polyester painted sheet as the standard, the inner surface and the sheets used for fixing the components are made of Aluminium and Zinc coated AZ 150 quality Aluzinc sheet. Both types of steel have been performing very well in the salt vapor test with the aim of measuring the corrosion resistance and have also been applied in harsh environments.



### DRAIN PAN

In EVO Modular air handling units, cooling coils, plate heat recovery exchanger and humidifier cells are equipped with a drain pan made of stainless steel, which is bi-directionally sloped and sealed. The drain pan and skid components are designed in accordance with VDI 6022 standard and have fast drainage and easy to clean structure.

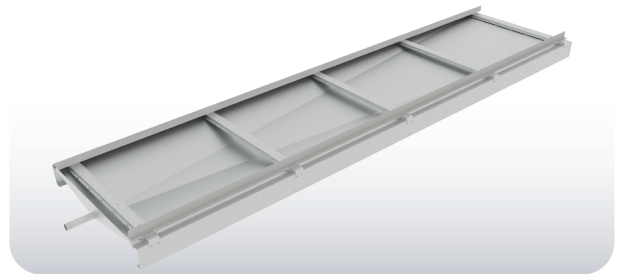

In units where the drain pan is used, one ball siphon is provided as standard with each drain pan. The siphon is designed for both situations where the cell is at a negative or positive pressure. In order to facilitate drainage according to the pressure on the cell, it is desirable to have a certain height between the drainage outlet and the waste water connection, which is indicated on the respective cell label. The desired height can be achieved with the help of the adjustable feet.

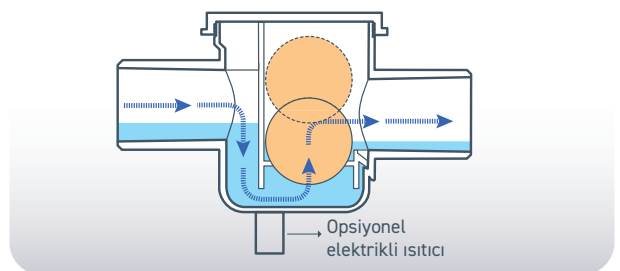

## EASE OF INSTALLATION

### Adjustable Feet

Planar disturbances at the installation site result in the fact that the central covers can not be fully opened or closed, a gap is formed around the panels, leakage occurs, internal components are damaged and service difficulties occur. To prevent this, the EVO Modular Air Handling Units are designed with adjustable feet to ensure that the unit is parallel to the ground plane. Adjustable feet also help maintain the minimum drainage height from the drain pan.

### Filter Frame

The filters in the unit are serviced by removing the service covers from the front of the unit as standard. In the applications up to the EVOXX20 model where the space is limited, the filters can be slidable and service can be done from the front. This allows a shortening of up to 600 mm in length of the device.

### Module Connectors

In EVO Modular Air Handling Units, sections are grouped so that the total length does not exceed 2500 mm. If the total length exceeds 2500 mm, the unit is divided into modules so that the length of each module does not exceed 2500 mm and the modules are joined on site. Air leakage may occur due to improper mounting during the assembly of modules, which affects performance. EVO Modular Air Handling Units have specially designed connecting plates and module connectors with 3 dimensional planes so that the module connections can be done easily and accurately.

### Outdoor Protection

EVO Modular Air Handling Units are designed to operate under atmospheric conditions. In AERA Selection software, the electrical components of the device are revised after entering the information that the device will work in the external environment and a roof plate is applied to the unit against rain and snow accumulation. It is recommended that the roofing plate be sloped to prevent snow accumulation in areas where snowfall is intense. Roof plate is manufactured from polyester coated sheet with high corrosion resistance.

### Adjustable Hinges and Locks

The lock and hinge mechanisms used in the units can be adjusted to  $\pm 3$  mm on all three axes. Axis problems caused by the mounting location, etc., are resolved as a standard feature in all devices.

## FILTERS

In EVO Modular Air Handling Units, pre-filters, middle-class filters and fine class filters are used according to particulate holding characteristics. Filters are produced as cassette, compact and bag type and selected the software according to the specification of the project. Depending on demand, Active Carbon filters can also be applied to retain odor and other chemical particles.

Filters are components that determine the pressure drop in air handling units to a significant extent. AERA selection software considers fan calculations by taking the average of the initial and final pressure drops of the filters during fan selection in line with Eurovent criteria.

### Size and Filter Classes of Some Particles in the Air

The filter class should be selected according to the size and type of particles desired to be held. The following table shows the particle sizes that are frequently seen in air conditioning systems and the recommended filter type to use.

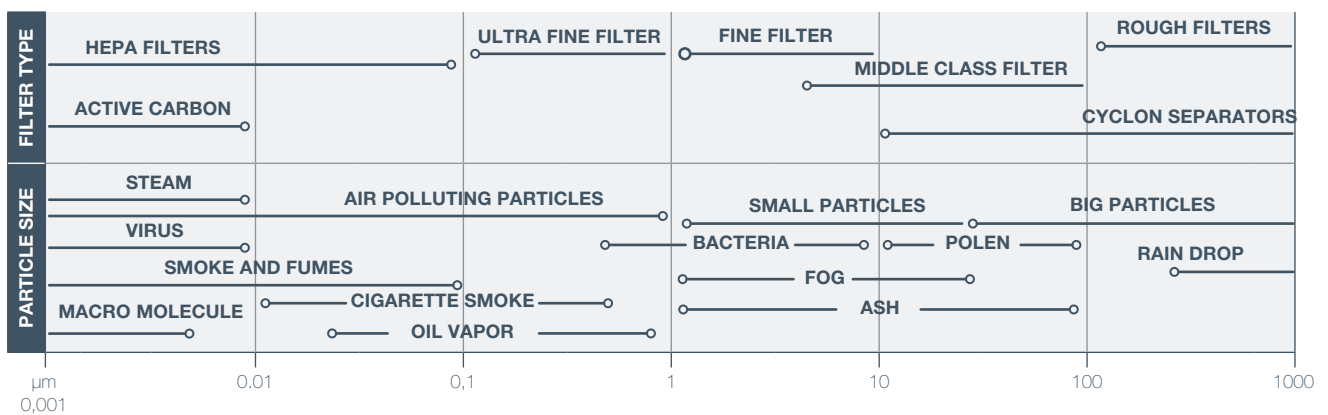

In order to monitor filter pollution and service times, pressure gauges can be installed on the unit. U manometers or differential pressure gauges show instantaneous readings, they can also inform the building automation system with a filter alarm if desired.

U MANOMETER



DIFFERENTIAL PRESSURE TRANSMITTER



DIFFERENTIAL PRESSURE GAUGE



**ROTOR**

EVO Modular Air Handling Units are manufactured using new materials and manufacturing technologies. Thanks to high technology, heat transfer efficiencies reach 85% in heating and cooling seasons. The stepping motor used as a rotor drive is suitable for automation and it provides optimum energy gain by changing the number of revolutions according to the heating and cooling needs. The stepper motor used provides up to 55% energy savings over conventional AC motors.

The part where the rotor rotates and the heat is transferred is called the matrix and it is formed by wrapping the high strength aluminum sheets with each other by giving a curly form.

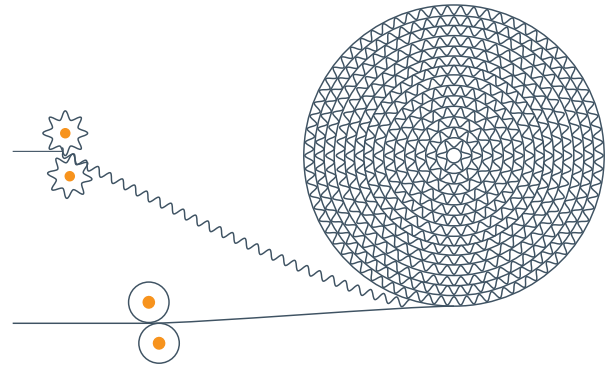

As well height (gap between wraps) increases, the amount of heat transfer and pressure drop is reduced. The decrease in well height increases the transfer of heat and pressure drop. In EVO Modular Air Handling Units, condensing type rotors with a 1.6 mm well height are used as standard. For higher heat transfer requirements, rotors with 1.8 mm, 2.0 mm or 2.5 mm well height can be selected from the selection software for 1.4 mm can be chosen for lower pressure drop requirements.

Rotors are produced in three different types by changing the matrix material used to meet different moisture transfer needs

- **CONDENSING** Aluminum material
- **ENTHALPY** Silica gel coated aluminum material
- **SORPTION** Zeolite coated aluminum material

The table below shows the heat and moisture transfer efficiencies of these three materials at different blwell heights.

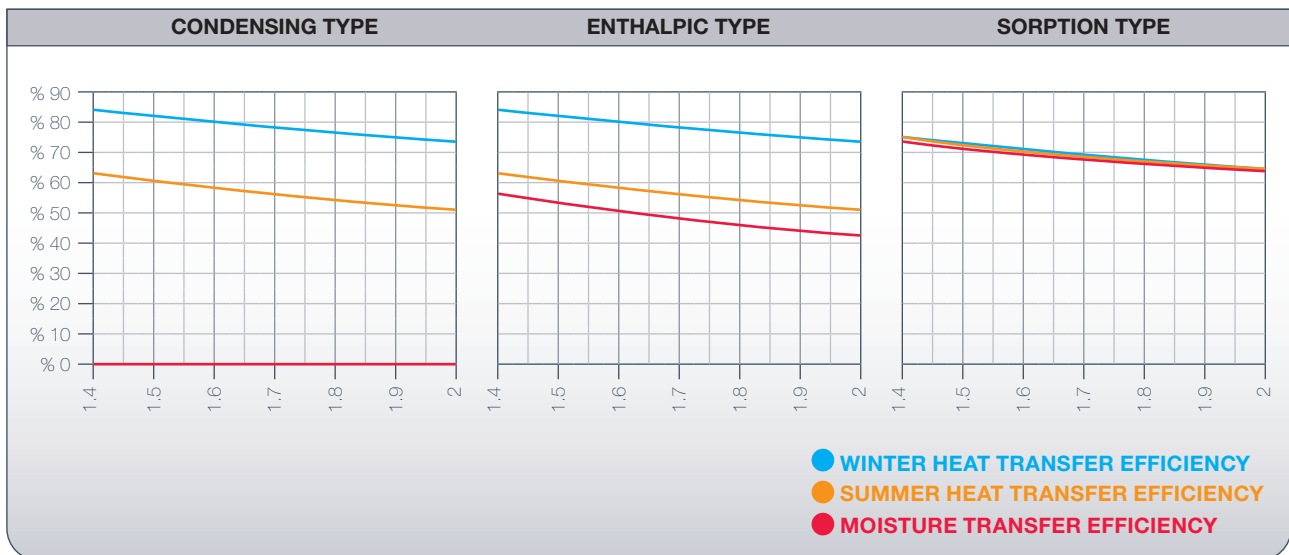

Condensing rotors are used in applications where moisture transfer is usually required during winter months and in summer where moisture transfer is not required. Moisture transfer to supply air takes place in the winter when extracted air condensates, whereas moisture transfer does not happen in summer because the possibility of condensation is very low. The smell and the chemical particles of the condensing air are transferred to supply air together with moisture. For this reason, it is not recommended to use condensing rotors in applications where there are smell and chemical particles in the exhausted air.

Enthalpy rotors are made by coating Silicagel over aluminum surface which enables moisture transfer. Silicagel absorbs humidity in the air and transfers it to the other air flow. Silicagel also allows the transfer of water-soluble molecules between air flows. It is not recommended to use it in applications where chemical particles are present in the exhaust air.

Sorption rotors are the result of the coating of Zeolite and such derivatized materials, which allows very high moisture transfer to the aluminum surface. Since water molecules can penetrate into the coating material, high moisture transfer occurs. The interspace between the molecules of the coating material allows only the passage of water molecules, blocking the passage of chemical substances such as odor.

In summer and winter conditions, heat transfer efficiencies similar to other materials are obtained, while moisture transfer efficiencies in sorption rotors reach 82%. This also plays an important role in reducing the latent heat load due to high fresh air in applications where especially the cooling load is high.

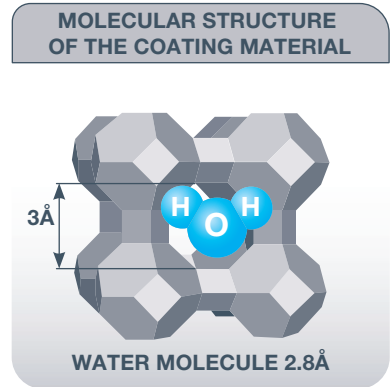

## AIR FLOW AND AIR TIGHTNESS

In EVO modular air handling unit selection, rotors are always designed to provide counter air flow. There is a loss of 35% in the heat and moisture transfer efficiencies when no counter flow is generated in the rotor.

### Sealing Gaskets

Due to the structure of the rotor there is air leakage between inside and outside of two surfaces. Gaskets previously used was able to reduce air leakage just under 3%. Evo Modular Air Handling unit's special sealing gaskets can reduce the air leakage under 1%.

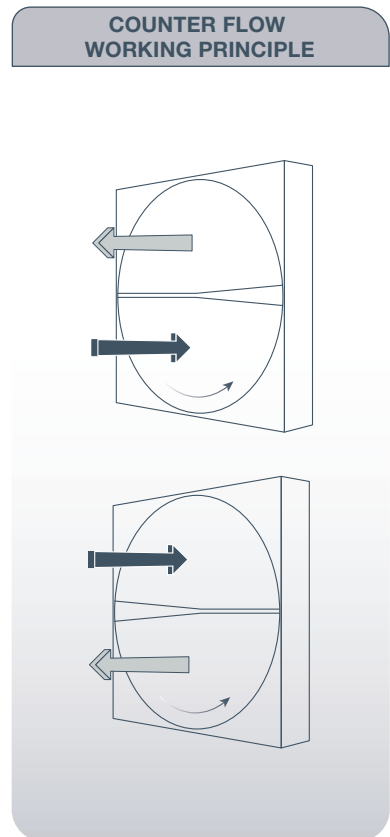



By selecting the configuration as shown in the figure in EVO Modular Air Handling Units, the static pressure values between the two air flows on the rotor will be very close to each other, so the leakage between the flows will be minimized. It is advisable to configure the units this way in modular air handling units just like compact units.

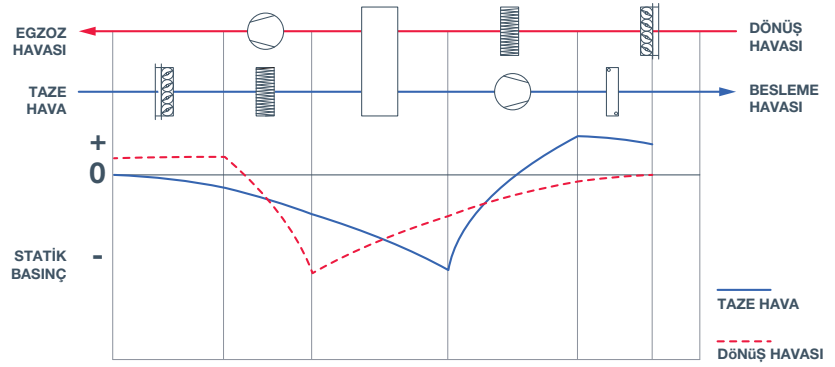

### PURGE SECTOR

In EVO Modular Air Handling Units, the rotors are equipped with a special Purge section in addition to special gaskets used to prevent the exhaust air from mixing into fresh air. The purge section is located between the two airflows, outside air is taken into purge section and this prevents exhaust air to be mixed with fresh air.

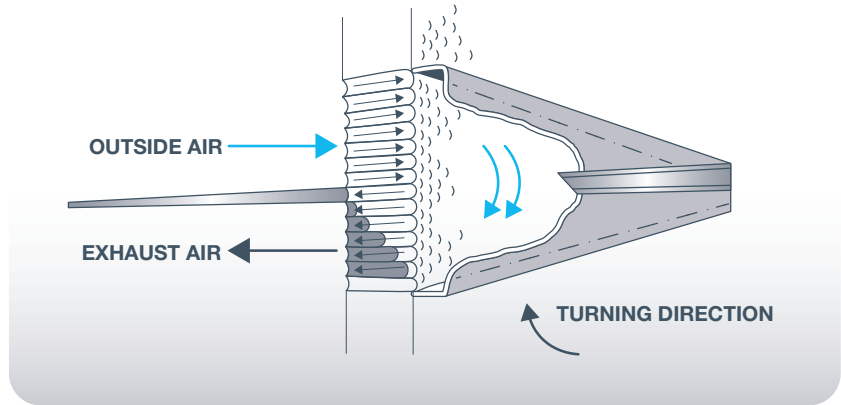

## SUPPLY AIR

In EVO Modular Air Handling Units, in order to provide heat transfer between hot or cold fluid and air quickly and efficiently, coils with copper tube / aluminum fin configuration are used. Two different coil geometries can be selected according to capacity requirement from selection software. The fins have a special form for increasing the heat transfer surface, reducing the risk of freezing and preventing the condensed water mixing with the air. Coil collectors are made of steel as standard, copper collectors may be used if required. In the coils there is an air purger and a water outlet as standard. The capacity of the coils is tested and approved at Eurovent laboratories.

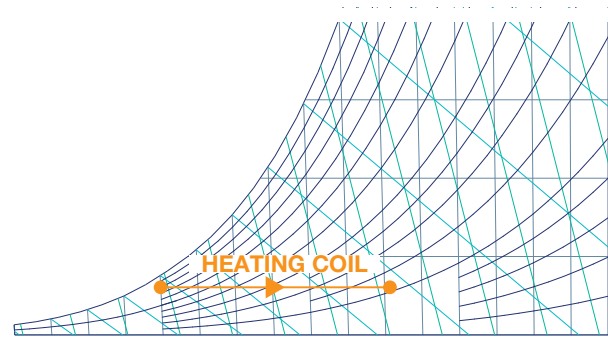

## Heating Coils

The heating coils are used as a preheater at the air handling unit inlet of fresh air and as a after heater to bring the supply air to the design temperature or to bring the dehumidified air to desired supply temperature. Water, water / anti-freeze mixture or refrigerant can be used as the fluid.

### ► Frost Protection

Frost protection independent of the control system in the heating coils is provided upon request. In a system with a set temperature of 0-15°C, when the water temperature falls below the set temperature, the alarm signal is activated and 24V and 230V relays are tripped, the proportional output on the frost protection sends signal to open the 2/3 way valve fully open.

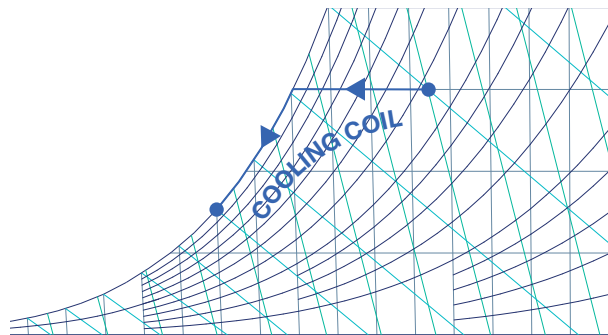

## Cooling Coils

Cooling Coils are used to bring supply air to the design temperature or to dehumidify the air into design absolute humidity levels. Water or refrigerant can be used as the fluid. Coils using refrigerant can be designed with multiple inputs and outputs to work with multiple outdoor units. Coils designed with multiple input-output batteries, each circuit is designed with cross circuitry to allow the circulating refrigerant to pass through the entire surface of the battery.

For removing the condensate formed in the cooling coils from the system, drain pans manufactured from stainless steel are used as standard. Drain pans are by welding and manufactured with double curved design to speed up the release of the condensate water. A ball siphon is supplied as standard with each machine against the transfer of chemical particles such as odor.

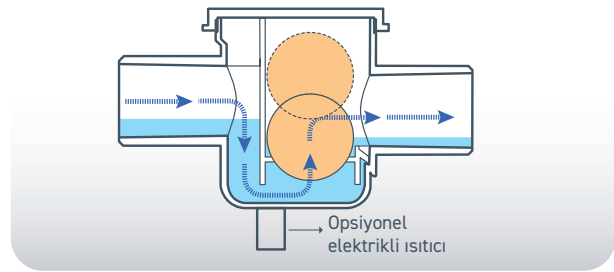
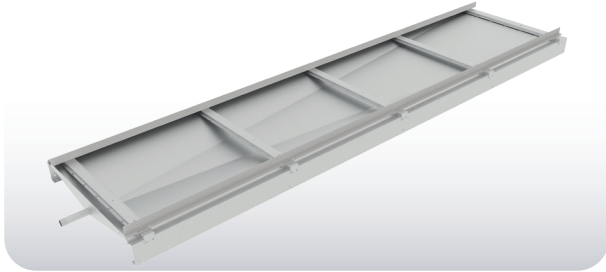

## HUMIDIFIERS

Humidifiers are used to increase the humidity of indoor air, especially in applications where outside air is cold and and fresh air is heated by internal heaters. The capacity and model of the humidifier are determined in the Selection software according to the desired air conditions and are reflected in the report together with all the selection criteria of the humidifier.

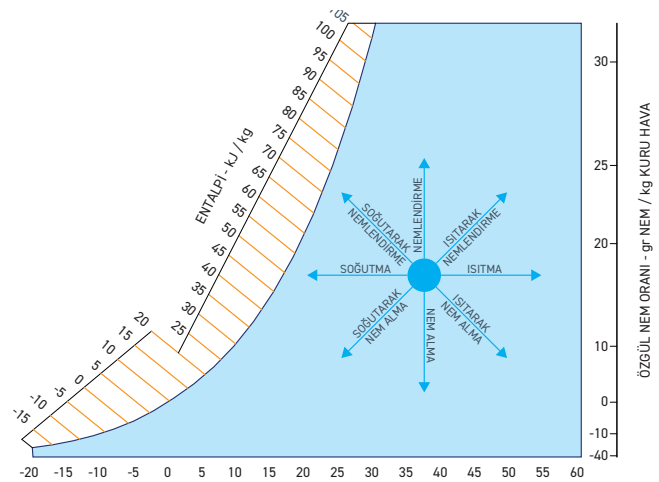

### Isothermal Humidifiers

In EVO Modular Air Handling Units, External Steam type using ready steam, Electrode type which obtains steam by vaporizing the softened water from the water treatment systems with the aid of its electrodes, and Resistance type steam humidifiers which obtain steam by using regular water can be used.

#### ► External Steam Type Humidifiers (FSH)

It is used when steam is supplied from a steam source in plant. The steam distributors are made of from stainless steel and special designed live steam jacket ensures any drops formed by condensation are immediately evaporated. The steam penetration distances start at 300 mm, depending on the entrance humidity and the desired moisture levels.

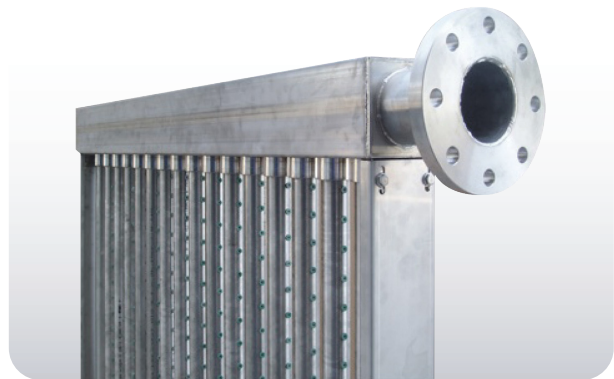

## Electrode Type Humidifiers (ELD)

Temperature of the water brought to running conditions is increased in a cylinder containing the electrodes made of stainless material and steam is obtained. Electrode surfaces have a special design to increase their service life and ensure proper heat dissipation. Suitable for use in hygienic applications, the humidifier has VDE, GS and CE certificates. The special cleaning system ensures the removal of sediments and other particles in the cylinder and increases the service life. They can meet the need for humidification up to 464 kg / h with modular construction.



## Resistance Type Moisturizers (RZT)

Drinable water taken from the tap is increased in temperature inside a detachable type cylinder with built-in immersion type resistance and steam is produced. The cylinder, made of plastic, is equipped with high temperature protection and level control element to prevent the resistances from running with incomplete water. The cylinder can easily be removed and cleaned. With the effective microprocessor control on it, the desired humidity value can be achieved with high accuracy ( $\pm 1\%$ ). Suitable for use in hygienic applications, the humidifier has VDE, GS and CE certificates. The special cleaning system ensures the removal of sediments and other particles in the cylinder and increases the service life.



## Adiabatic Humidifiers

Adiabatic humidifiers are used in the HEF2E series for adiabatic cooling or humidification in EVO Modular Air Handling Units. They have low energy consumption and manufactured with the VDI 6022 hygiene certificate. The system is designed to have high efficiency and low pressure drop, it has a flame retardant glass fiber humidifier pad, circulation pump, flow balancing valves, droplet eliminators and level sensors. Optionally step controlled, simple or advanced automation and ultraviolet lamp sterilization system can be installed with the humidifier.



## FANS

In EVO Modular Air Handling Units, different types of fans can be selected according to required flow rate and static pressure requirements of the project and the variability of these needs. Depending on the requirements of the users, plug type fans with direct coupling motors or EC motors, forward inclined or backward inclined belt and pulley connected fans can be used. Fan-array applications which reduces the sound pressure of the project and reduces the size of the unit can also be selected.

### Forward Inclined Fans

These fans are mostly used in cost-oriented low/medium static pressure applications and they belong to medium efficiency class. Fresh air units and aspirators that does not require cleaning are their common area of application. It is not advised to use them where system static pressure may differ a lot from the design conditions.

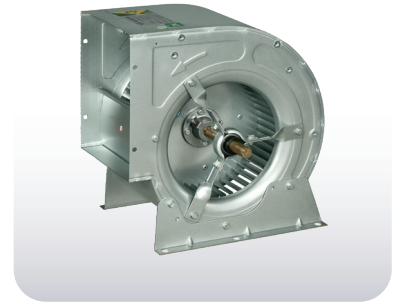

### Backward Curved Fans

Backward inclined fans are used in medium/high static pressure applications and they belong to high efficiency class. Aspirators, fresh air units, air handling units with recirculation and heat recovery air handling units are their frequent used applications. Due to the nature of the operating and performance curves they are suitable for variable flow and variable pressure applications and speed control.



### Plug type fans

These fans are used in medium/high static pressure applications and they belong to high efficiency class. Since the fan and motor are directly coupled to each other, the losses in the belt / pulley system are eliminated. The plug type fans must be driven with a frequency converter in order to run them at the design conditions and to set the speed. The wing structure is an aerofoil structure to enhance aerodynamic efficiency. They can be used in all aspirators, including applications where the air should not be in touch with the motor, fresh air handling units, units with recirculation, heat recovery ventilators and hygienic air handling units.

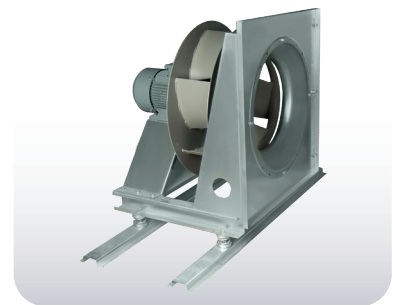

### Plug fans with EC motors

It is used in applications where medium / high static pressure is needed. These fans have IE4 very high efficiency class electronically controlled motors. The blade structure is an aerofoil structure to enhance aerodynamic efficiency. Plug type fans with EC motors are integrated to selection software and technical report on operating conditions is also specified.



All EC motor plug type fans used in EVO Modular Air Handling Units are in compliance with European Union Energy Norm (ERP) with very high efficiency. They have electronic components for easy operation according to many control systems (Constant Air Volume CAV, Constant Static Pressure / Variable Air Volume, VAV)

All EC Motor Plug Fans used in EVO Modular Air Handling Units have MODBUS communication protocol, control signals and alarm information can be transferred to the main control panel just with a dual cable.

In addition to high energy efficiencies, the compact design and space-saving EC Motor driven Plug fans can be used as a fan array in bigger airflows to meet the need in a very small area. Selection software can automatically select up to 6 fans for the fan array. This application not only creates a compact structure, but also a continuity of operation in case of a failure or maintenance times.

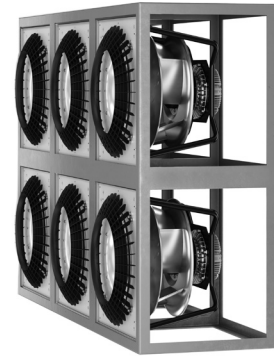

## Fan Laws

The speed, power and pressure interactions in the fans used in the EVO Modular Air Handling Units are predictable and explained in the fan laws. Using these laws and the change in the fan rpm, it is possible to obtain an estimate of what the pressure and power values will be at the new working point.

FLOW ~ SPEED	PRESSURE ~ (SPEED) <sup>2</sup>	POWER ~ (SPEED) <sup>3</sup>
$\frac{Q_1}{Q_2} = \frac{N_1}{N_2}$	$\frac{SP_1}{SP_2} = \left( \frac{N_1}{N_2} \right)^2$	$\frac{P_1}{P_2} = \left( \frac{N_1}{N_2} \right)^3$
<p>Varying the RPM by 10% decreases or increases air delivery by 10%.</p>	<p>Reducing the RPM by 10% decreases the static pressure by 19% and an increase in RPM by 10% increases the static pressure by 21%</p>	<p>Reducing the RPM by 10% decreases the power requirement by 27% and an increase in RPM by 10% increases the power requirement by 33%</p>

Q - Flow, SP - Pressure, P - Power (kW) ve N - Speed (RPM)

## MIXING CHAMBER

In EVO Modular Air Handling Units, mixing chambers are designed with the purpose of mixing fresh air with return air coming from indoors before supplying it back indoors. Mixing chambers are often used with the aim of meeting the need for fresh air supply in applications where direct ventilation of the kitchen / toilet ventilation systems is required, or when the air conditioning unit is used to pressurize premises.

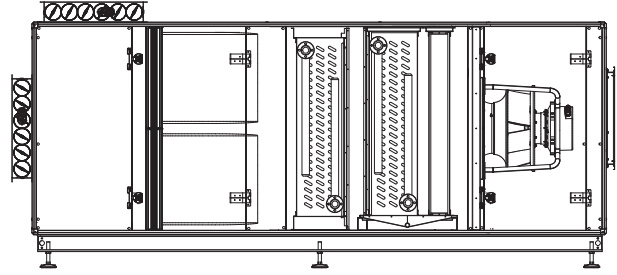

AERA Selection software automatically calculates the mixture air conditions according to the user's specified mixture air flow and weather conditions in case of selecting mixing chamber. This information is supplied to other components such as filters, coils, fan etc. automatically, eliminating the need for manual calculation by user.

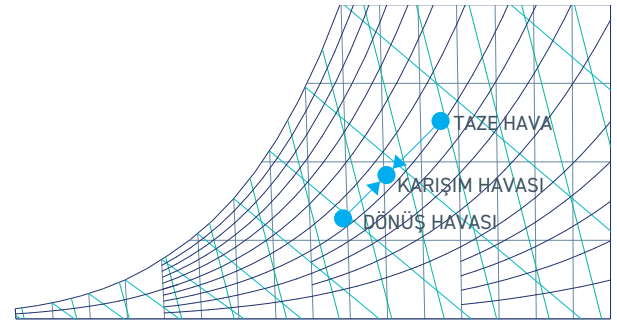

## ECONOMISER

In the EVO Modular Air Handling Units, the economizer section is designed to be used with a return fan for the purpose of providing specified amount of fresh air indoors. It is possible to increase the fresh air ratio to provide optimum mixing air using the control system. Using economizer cell it is possible to keep the indoors under negative or positive pressure.

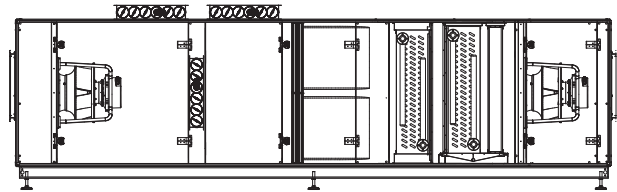

For air flow adjustment, a resistance is created in the economizer damper and the return air / fresh air ratio in the mixing air is adjusted according to the pressure drop created. The AERA Selection software automatically calculates the mixture air conditions according to the outside air conditions and mixing ratios specified by the user when the economizer section is selected. This information is automatically transferred to next section such as filter, battery, fan etc.

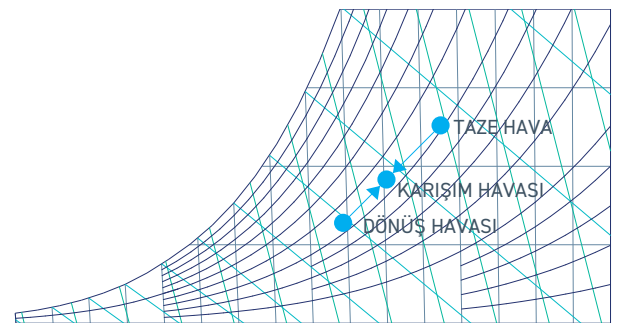

## SOUND ATTENUATOR

EVO Modular Air Handling Units have a silent design thanks to low velocity criteria in construction and component selection that prevent turbulence in casign design. In cases where the units are located adjacent to living volumes, where it is desired that the sound of unit has to be even lower, sound attenuators can be used.

Silencers can be installed in the units or in the air ducts when space is limited. The silencers located in the unit have higher sound damping characteristics and lower sound pressure levels than the silencers in the air duct ( $V_s \leq 6.0 \text{ m/s}$ ) due to low velocities ( $V_s \leq 2.0 \text{ m/s}$ )

Silencer sections are produced in 600, 1000 and 1500 mm lengths. For optimum pressure drop and sound damping level, silencer pods 200 mm wide are placed at 100 mm distance from each other. Sound absorption level and pressure drop criteria for standard lengths are indicated on the table.

The sound damping values tested by ISO 7235 for silencers are given in the selection software and in the report output according to the selection criteria. The silencers are designed in accordance with the hygiene criteria of VDI 6022 and DIN 1946 (parts 1 and 2). In order to periodically clean the silencer pods, appropriate service panels are designed on the unit casing and the pods are designed to be easily removable.

Silencers used in EVO modular air handling units are pods created by placing blocks of rock wool which has A1 fire class rating according to EN 13501 in a frame made of sheet metal. The rock wool is assembled with a special sheath to prevent the parts from escaping into the air stream. Sheet frame has aerodynamic design with rounded air inlets and outlets in order to reduce the pressure drops and turbulence.

Pod width (B) = 200 / Pod length (S) = 100 mm

Length mm	Damping [dB] for medium frequency [Hz]								Pressure value $\xi$
	63	125	250	500	1K	2K	4K	8K	
500	3	5	10	19	24	20	15	11	5.7
1000	5	8	15	33	44	36	23	15	6.6
1500	7	12	21	46	50	50	32	19	7.5
2000	9	16	27	50	50	50	40	23	8.5
2500	11	20	33	50	50	50	49	27	9.4

Dp pressure loss is calculated from the pressure value.

$$\Delta p = 0,6 \times v^2 \times \xi$$

v is the speed at the cross section of the silencer.

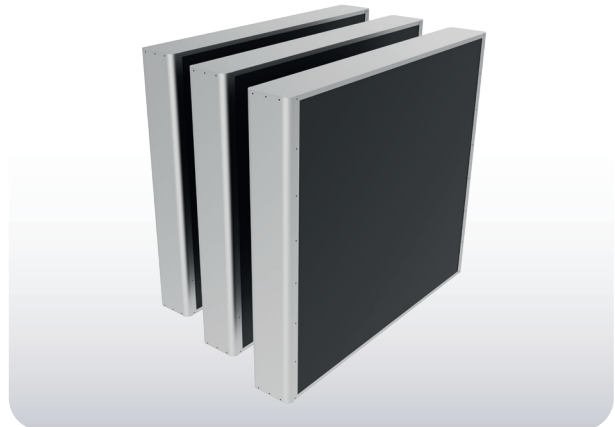
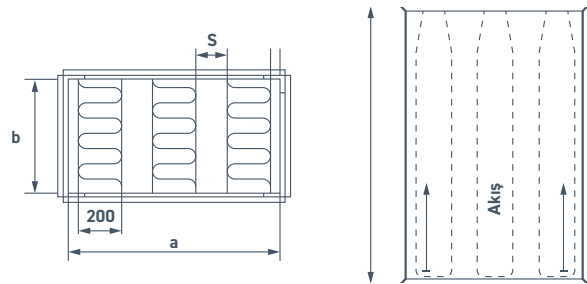



## ELECTRICAL HEATER

EVO Electric Heater Section is designed as a preheater in very cold climates where electrical resistance is used as a heat source in modular air handling units or as a after heater / reheater in applications where there is no other heat source. In addition to comfort applications, electrical heaters are used in applications where the temperature is to be controlled sensitively and the response times should be short.

Electric heaters are equipped with 2 types of overheat safety thermostat as standard. One of the thermostats automatically cuts off the energy supply when it reaches the temperature set in the factory and automatically restarts when the ambient temperature drops. The other thermostat is set at a higher temperature (110 °C) and cuts off the energy when the temperature reaches the set value, and requires manual intervention by technical personnel after checking the cause of overheating.

In EVO Modular Air Handling Units, the heater face velocity is 3 ~ 3.5 m / s in order to provide optimum surface temperature / pressure drop values in the electric heaters. In AERA selection software, electric heater sections are automatically designed according to the capacity and air flow required in applications.

Electric heaters are manufactured in accordance with step control. In models with three phases, electric heaters are designed with equal load to each phase. They are shipped with electric panels ready for capacity control.

Depending on the application in the project, a step or proportional kit is available as an option. These kits can be configured with external on / off or proportional signal which automatically changes the electric heater capacity. If the electric heater is used as frost protection in very cold climates, the electric heater can be controlled with the optional Frost Protection Control kit.

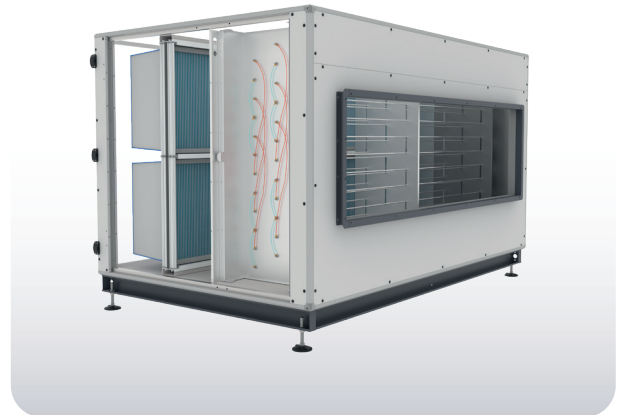

## HEATERS

### Electrical Heaters

Electrical heaters are used for purposes such as increasing supply air temperature, preheating fresh air from the outside, bringing the supply air to the desired temperature after dehumidification process. With SENSO PLUS control, electric heaters are driven in steps or proportional manner according to desired set temperature to save energy. All safety and operating equipment required by the electric heater is supplied standard with the SENSO PLUS control.

### Heating Coil

Heating coils are used for increasing the supply air temperature and for bringing the supply air to the desired temperature after dehumidifying process. Hot water coils can be driven by proportional control via 2 or 3 way valves. With the SENSO PLUS control, frost protection mechanism is available as standard to prevent the temperature of the supply water from reaching freezing conditions in extreme cold climates. If the return water temperature falls below a certain value set on the control, the heating valve is switched to the 100% open position and a run signal is sent to the heating water circulation pump. If the temperature still does not rise to the desired value, the device is stopped and the user is given a freeze alarm.

### DX (Condensing) Coil

They are used for increasing the supply air temperature and for bringing the supply air to the desired temperature after dehumidifying process. They can be step controlled with on/off method, maximum 16 step settings are available.

## COOLERS

### Cooling Coil

Cooling coils are used to lower the supply air temperature and dehumidification process. Cooling coils are controlled with 2 or 3 way valves. Run signal will be sent to cold water circulation pump when necessary.

### DX (Evaporator) Coil

They are used to lower the supply air temperature and dehumidification process. They can be step controlled with on/off method, maximum 8 step settings are available.

### Changeover Coils

These coils can have cooling in the summer season and heating in the winter season. Their capacities are usually selected according to cooling conditions. Heating and cooling capacity is controlled and has frost protection during heating season.

## FAN

### Constant Air Volume

Nominal air flow and reduced air flow are defined as two control values. SENSO PLUS control measures the air pressure drop in the suction ports of the fans and compares the air flow with the set value to produce a working signal for the frequency converter or EC fan.

Contamination of the filters can be controlled by static flow control within the fan operating curve, to the static pressure requirements of the unit which result in higher or lower than the project values.

### Constant Air Pressure

In EVO Modular Air Handling Units, constant pressure control is used to meet the variable airflow requirement of the air duct system. The SENSO PLUS control generates a working signal to frequency converter or EC Fan that will change the fan speed by continuously measuring the static pressure created in the supply air duct and comparing it with the value defined in the system. When a VAV damper opens or closes, higher or lower external static pressure needs can be met with constant pressure control within the fans operating curve. This way extreme noise in the ducts, unbalanced airflow distribution in different volumes is prevented.

### Indoor Air Quality Control

The air quality sensor or the CO<sup>2</sup> sensor, which is placed in the critical volume or return channel in the interior, continuously measures the air quality. This value generates a signal to frequency converter or EC Fan that will change the fan speed by comparing it to the set point on the controller. If the indoor air quality is lower than the desired value, the fan speed and thus the fresh air amount is increased; if the indoor air quality is higher than the desired indoor air quality, the fan speed and fresh air speed are decreased; Energy saving is achieved in considerable amounts in heating or cooling loads caused by fresh air.

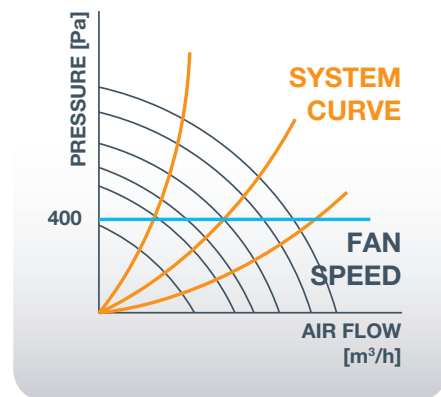
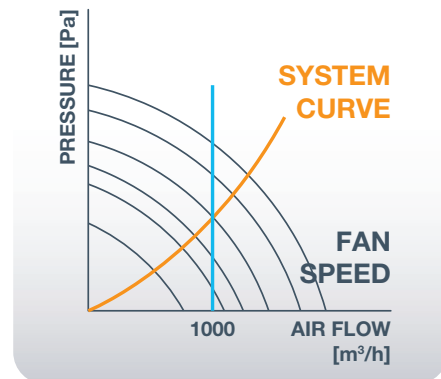

## FILTERS

The pressure drops of the filters used to clean the air, can be controlled by SENSO PLUS control. Users are notified about the filter cleaning and replacement intervals. Pressure drop control can be made according to a constant pressure drop (Static) or variable air flow (Dynamic). Especially with units designed with variable speed fans, Dynamic Filter Control enables filter service at the right time.

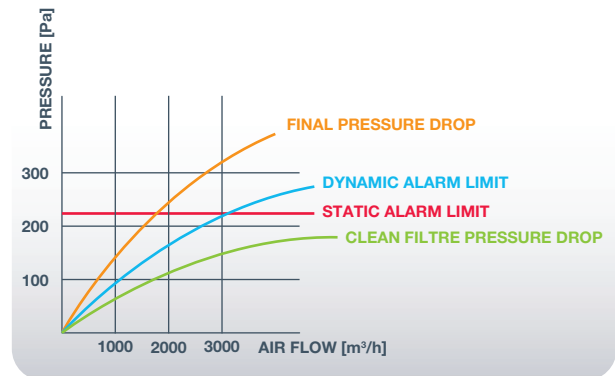

## HEAT EXCHANGERS

### PLATE TYPE HEAT EXCHANGER CONTROL

In EVO Modular Air Handling Units with plate type heat exchangers, there is a by-pass damper in order to be able to deliver the outside air directly into the exchanger without entering the heat exchanger under suitable weather conditions. The SENSO PLUS control uses temperature sensors to determine when the by-pass will be turned on and off. This function, also known as Free Cooling, saves energy by opening the by-pass dampers when the outside air is suitable.

In extreme cold climates fresh air preheater can be used to prevent the air condensation on the plated type heat exchanger from freezing and damaging the heat exchanger. If this is not enough, by-pass damper is opened to prevent the cold air from passing over the heat exchanger. In such applications, referred to as heat exchanger frost protection, an afterheater must be built in the device and this heater must be chosen to meet the necessary supply air conditions.

### Rotary Type Heat Exchanger

In EVO Modular Air Handling Units, when the SENSO PLUS control is used together with the rotary exchanger, the unit is shipped with a variable speed rotor drive. By controlling the supply air temperature, the rotor revolutions are automatically adjusted according to the required heat recovery. If the outside air conditions are appropriate, the rotor is stopped and free cooling is performed.

## DAMPERS

In EVO Modular Air Handling Units, if the SENSO PLUS control is used, the Economizer and Mixer dampers are automatically adjusted according to the desired mixture air conditions and the amount of fresh air. The recirculation dampers, which allow the use of variable indoor / fresh air, are also automatically adjusted according to desired supply air temperature.

## HUMIDITY CONTROL EQUIPMENT

Humidity control equipments are used to raise or lower the humidity of the supply air. With the SENSO PLUS control, the humidifier / de-humidifiers can be controlled to bring the supply air to the desired humidity value.

The SENSO PLUS control also provides system control besides equipment control, which means that the devices can be operated with the Yearly Timer Function according to the working periods: Daily, Weekly, Monthly or Yearly. In the Timer Function, values such as weekly working days, vacation times, daylight savings time can be defined and reported retrospectively.

Besides, the Support Function which is used to prevent the undesired conditions from occurring indoors even when the device is not working. The indoor temperature from falling below or exceeding a certain value even during non-working hours is ensured.

**COMMUNICATION OPTIONS**

SENSO PLUS control supports all of the universal communication protocols and interacts with other air handling units as well as with other building automation systems. ModBUS, BACnet and EXOline protocols are open as standard and there is also possibility to connect with LONWORKS protocol as an option.



**USER INTERFACE**

With SENSO PLUS control, a standard control panel with a keypad as a user interface is delivered, optionally touch screen user interfaces are available as well. There is also a web server embedded in the card for monitoring and controlling the device through a computer. Settings for the controller can be done over the server, instantaneous operating values of the unit can be seen, as well as retroactive working values can be followed.

**WEB INTERFACE (CLOUD CONTROL)**

SENSO PLUS control connects the web server over the internet and allows you to view and change the settings of your unit on any computer / tablet or mobile phone anywhere in the world. No need for complicated network settings, only a connected network cable is enough. With this feature, it is possible to monitor and control all units from different projects on a single screen, so that all of the operating values, active alarms, settings can be observed and remotely changed. Cloud control is an option provided with SENSO PLUS, which is especially convenient when it is important to serve multiple devices within seconds, in different projects all around the world.

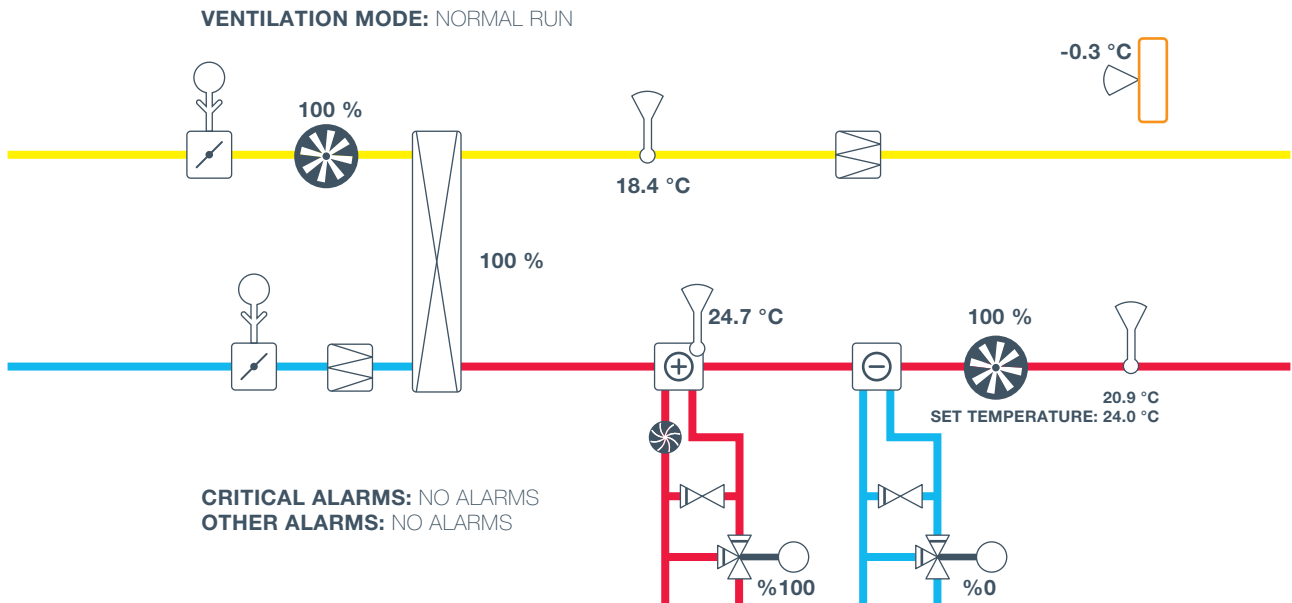

# UNIQUE ADVANTAGES OF SENSO PLUS CONTROLS

- TCP / IP connection: The integrated web control console provides platform-independent remote monitoring and setting. Tablet, PC, smartphone provides you with 24/7 accessibility to your unit.
- BACNet, Modbus, EXOline, LON and CLOUDigo communication ports provide easy integration into all automation systems.
- With the modular structure, components in the unit can be added or deactivated after the installation.
- It provides a quick and easy configuration program from the computer and ease of operation with plug-and-play logic.
- Energy is saved;
  - By providing fresh air as much as the volume needed, it optimizes the air conditioning load resulting from fresh supply air.
  - Runs all components at their optimum points to achieve the desired supply temperature.
  - It optimizes the heat recovery operation according to indoor and outdoor weather conditions, provides free cooling at appropriate temperatures.
  - Provides filter service by constantly observing the pressure drops over the filters and informing the user accordingly.
- It provides instant information about problematic components with advanced alarm signals.
- All components of the control are supplied from a single point, so they fit perfectly and work seamlessly.
- The optional CLOUDigo platform; The system, which allows you to extend and is designed with maximum convenience, is ready to use when you plug in an ethernet cable. All devices using the SENSO PLUS control system can be viewed and controlled from a single screen.
- The devices continuously send data to the system and the data are recorded. Reports on energy efficiency can be generated by analyzing detailed data within specific dates.

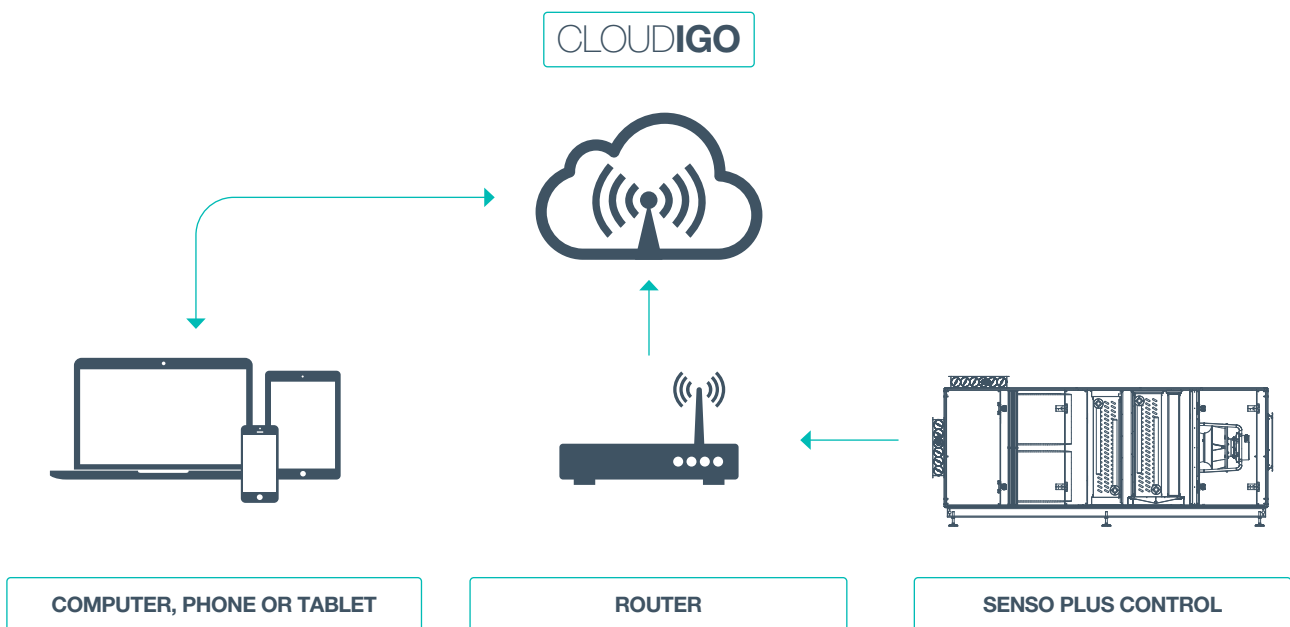





**AERA Air Conditioning Ventilation  
Technologies Corporation**

**Factory I:** 14. Cadde, No:13, Pancar OSB

**Factory II:** 3. Cadde, No:13, Pancar OSB

Torbalı/İzmir-Türkiye, +90 232 799 01 11

**E-mail:** sales@aera.com.tr

**Sales Headoffice:** Özdemir Sok. Kurtuluş Apt. No: 5

Kadıköy/İstanbul-Türkiye, +90 216 504 76 86



[aera.com.tr](http://aera.com.tr)

